

4S, S4S, 5S, 6S, 6SR, S6SR, 6PR, 8S, S8S, 8P, 10S, S10S, 12S & S12S

OPERATOR'S MANUAL

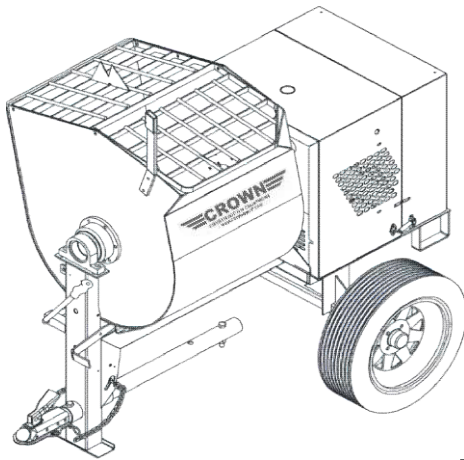

SERIES BULLETIN No. SUPERSEDES DATE
 All - Mach 200078-R04
 200078-R03
 Jan 2012

P.O. BOX 73, STATION L
WINNIPEG, MANITOBA
CANADA R3H 0Z4

PHONE (204) 831-8468
TOLL-FREE (877) 403-1220
FAX (204) 831-8590



WARNING



CALIFORNIA - Proposition 65 Warning

Engine exhaust and some of its constituents and some dust created by power sanding, sawing, grinding, drilling and other construction activities contains chemicals known to the State of California to cause cancer, birth defects and other reproductive harm.

Some examples of these chemicals are: -

- Lead from lead-based paints Crystalline silica from bricks
- Cement and other masonry products Arsenic and chromium from chemically treated lumber

Your risk from these exposures varies, depending on how often you do this type of work. To reduce your exposure to these chemicals: **ALWAYS** work in a well-ventilated area, and work with approved safety equipment, such as dust masks that are specially designed to filter out microscopic particles.

1 INTRODUCTION

Congratulations on your choice of a Crown Construction Equipment Mortar Mixer to complement your construction operation. This equipment has been designed and manufactured to meet the needs of a discriminating buyer for the efficient mixing of mortar or plaster.

Safe, efficient and trouble-free operation of your Crown Mortar Mixer requires that you and anyone else who will be operating or maintaining the Mixer, read and understand the Safety, Operation, Maintenance and Trouble Shooting information contained in the Operator's Manual.



This manual is applicable to all the Model 4S, 5S, S5S, 6S, S6S, 6SR, S6SR, 8S, S8S, 8P, 10S, S10S, 12S and S12S Mortar Mixers built by Crown Construction Equipment. Use the Table of Contents or Index as a guide when searching for specific information.

Keep this manual handy for frequent reference and to pass on to new operators or owners. Call your Crown Construction Equipment distributor or dealer if you need assistance or information.

OPERATOR ORIENTATION - The directions left, right, front and rear, as mentioned throughout this manual, are as seen from behind the machine and facing in the direction of towing.

2 SAFETY

SAFETY ALERT SYMBOLS

This Safety Alert symbol means **ATTENTION! BECOME ALERT! YOUR SAFETY IS INVOLVED!**



The Safety Alert symbol identifies important safety messages on the Crown Mortar Mixer and in the manual. When you see this symbol, be alert to the possibility of personal injury or death. Follow the instructions in the safety message.

Why is SAFETY important to you?

3 Big Reasons

Accidents Disable and Kill
Accidents Cost
Accidents Can Be Avoided

SIGNAL WORDS: Note the use of the signal words DANGER, The Safety Alert symbol identifies important safety messages on the Crown Mortar Mixer and in the manual. When you see this symbol, be alert to the possibility of personal injury or death. Follow the instructions in the safety message. This Safety Alert symbol means ATTENTION! BECOME ALERT! YOUR SAFETY IS INVOLVED! WARNING and CAUTION with the safety messages. The appropriate signal word for each message has been selected using the following guide-lines:

DANGER - Indicates an imminently hazardous situation that, if not avoided, will result in death or serious injury. This signal word is to be limited to the most extreme situations, typically for machine components that, for functional purposes, cannot be guarded.

WARNING - Indicates a potentially hazardous situation that, if not avoided, could result in death or serious injury, and includes hazards that are exposed when guards are removed. It may also be used to alert against unsafe practices.

CAUTION - Indicates a potentially hazardous situation that, if not avoided, may result in minor or moderate injury. It may also be used to alert against unsafe practices.

SAFETY

YOU are responsible for the SAFE operation and maintenance of your Concrete Mixer. YOU must ensure that you and anyone else who is going to operate, maintain or work around the Concrete Mixer be familiar with the operating and maintenance procedures and related SAFETY information contained in this manual. This manual will take you step-by-step through your working day and alerts you to all good safety practices that should be adhered to while operating the Mixer.

Remember, YOU are the key to safety. Good safety practices not only protect you but also the people around you. Make these practices a working part of your safety program. Be certain that EVERYONE operating this equipment is familiar with the recommended operating and maintenance procedures and follows all the safety precautions. Most accidents can be prevented. Do not risk injury or death by ignoring good safety practices.

- Mixer owners must give operating instructions to operators or employees before allowing them to operate the machine, and at least annually thereafter.
- The most important safety device on this equipment is a SAFE operator. It is the operator's responsibility to read and understand ALL Safety and Operating instructions in the manual and to follow these. All accidents can be avoided.
- A person who has not read and understood all operating and safety instructions is not qualified to operate the machine. An untrained operator exposes himself and bystanders to possible serious injury or death.
- Do not modify the equipment in any way. Unauthorized modification may impair the function and/or safety and could affect the life of the equipment.

7. Stop engine, disconnect spark plug wire and wait for all moving parts to stop before servicing, adjusting, repairing or cleaning.

8. Wear appropriate hearing protection when operating for long periods of time.

Dust Hazard ~ Wear appropriate dust mask around this equipment.

9. Ventilation ~ Never operate any gas-powered equipment in a poorly ventilated or enclosed area. Avoid prolonged breathing of exhaust gases.

11. Hot Surface ~ Avoid contact with hot exhaust system and engine. Allow to cool before performing repairs or service.



2.1 GENERAL SAFETY

- Read and understand the Operator's manual and all safety signs before operating, maintaining, adjusting, servicing or cleaning the Mixer.
- Only trained competent persons shall operate the Mixer. An untrained operator is not qualified to operate the machine.
- Have a first-aid kit available for use, should the need arise and know how to use it.
- Do not allow riders when towing.
- Have a fire extinguisher available for use should the need arise and know how to use it.



12. Electrocution Hazard ~ Always use proper size grounded extension cord. Inspect all extension cords for cuts, frayed wire and broken connectors. Do not use cords if not in good condition.



6. Wear appropriate protective gear. This list includes, but is not limited to:

- A hard hat
- Protective boots with slip resistant soles
- Protective goggles
- Heavy gloves
- Hearing protection



7. Do not refuel the machine while smoking or when near open flame or sparks



2.2 OPERATING SAFETY

- Understand the Operator's Manual & all safety signs before operating, servicing, adjusting, or cleaning the Mixer.
- Do not allow riders on the machine during transport.
- Install, close and secure all guards, shields and hoods before starting or operating.
- Stop engine or motor, disconnect spark plug wire or unplug power cord, and wait for all moving parts to stop before servicing, adjusting, repairing, or cleaning.
Clear the area of all bystanders before starting.
- Keep hands, feet, hair and clothing away from moving parts.
- Keep working area clean and dry to prevent slip-ping and tripping.
- Do not run the mixer in an explosive atmosphere or in a poorly ventilated or enclosed area.
- Wear appropriate hearing protection when operating for long periods of time.
- Always attach safety chain when towing.
- Do not exceed a safe travel speed when towing. Slow down for corners and when going over rough terrain.
- Review safety instructions with all operators annually.

Gas engine powered units:

- Do not place hands in the drum unless the engine is OFF and the spark plug wire is disconnected.
- Stay away from hot engine components during operation.
- Do not smoke when refueling gas engine. Electric motor- powered units:
- Do not place hands in the drum unless the motor is OFF and the power cord unplugged.
- Have a licensed electrician wire up and provide power to the motor.
- Only use a power cord that is grounded.
- Always use an electrical cord with the required power carrying capacity.

2.3 MAINTENANCE SAFETY

- Review Operator's Manual and all safety items before working with, maintaining or operating the Mixer.
- Stop engine or motor, disconnect spark plug wire or unplug power cord, and wait for all moving parts to stop before servicing, adjusting, repairing, or cleaning.
- Follow good shop practices
 - Keep service area clean and dry.
 - Be sure electrical outlets and tools are properly grounded.
 - Use adequate light for the job.
- Keep hands, feet, clothing and hair away from all moving and/or rotating parts.
- Do not place hands in the drum unless the engine is off and the spark plug wire is disconnected or the power cord is unplugged.
- Do not attempt any adjustment or maintenance to any system of the Mixer unless the power source is disabled.
- Make sure that all guards, shields and hoods are properly installed and secured before operating the Mixer.
- Securely support the machine using blocks or safety stands before working beneath it or changing tires.
- Store & transfer gasoline, solvents, cleaners or any flammable liquids only in safety standard containers.



2.4 TRANSPORT SAFETY

- Read and understand ALL the information in the Operator's Manual regarding procedures and SAFETY when operating the Mixer in the work- place and/or on the road.
- Always travel at a safe speed. Use caution when making corners or on a rough surface.
- Make sure all the lights and reflectors that are required by the local highway and transport authorities are in place, are clean and can be seen clearly by all overtaking and oncoming traffic.
- Do not allow riders on any part of the machine during either road or highway travel.
- Always use a safety chain between the Mixer and the towing vehicle when transporting.
- Use a mechanical retainer through the ball hitch or clevis pin before transporting.
- Ensure wheel nuts and axle hardware are tight.

2.5 TIRE SAFETY

- Failure to follow proper procedures when mounting a tire on a wheel or rim can produce an explosion which may result in serious injury or death.
- Do not attempt to mount a tire unless you have the proper equipment and experience to do the job.
- Have a qualified tire dealer or repair service per- form required tire maintenance.

2.6 STORAGE SAFETY

- Store unit in an area away from human activity.
- Do not permit children to play on or around the stored Mixer.

2.7 REFUELING SAFETY

- Handle fuel with care. It is highly flammable.
- Allow engine to cool for 5 minutes before re- fueling. Clean up spilled fuel before restarting engine.
- Do not refuel the machine while smoking or when near open flame or sparks.
- Always use an approved fuel container.
- Fill fuel tank outdoors.
- Prevent fires by keeping machine clean of accumulated trash, grease and debris.



2.8 ELECTRICAL SAFETY

- Have a licensed electrician wire up and supply power to the electric motor.
- Always use a grounded power cord with the re- quired capacity to carry the power to the motor.
- Route the power cord out of the way or protect from damage.
- Turn motor off, unplug power cord or turn off power at master panel and wait for all moving parts to stop before servicing, maintaining, adjusting or cleaning.
- Keep all electrical components in good condition.

2.9 SAFETY SIGNS

- Keep safety signs clean and legible at all times
- Replace safety signs that are missing or have become illegible.
- Replaced parts that displayed a safety sign should also display the current sign.
- Safety signs are available from your Distributor or the factory.

How to Install Safety Signs:

- Be sure that the installation area is clean and dry.
- Decide on the exact position before you remove the backing papers.
- Remove the smallest portion of the split backing paper.
- Align the sign over the specified area and carefully press the small portion with the exposed sticky backing in place.
- Slowly peel back the remaining paper and carefully smooth the remaining portion of the sign in place.
- Small air pockets can be pierced with a pin and smoothed out using the piece of sign backing paper.

2.10 SIGN-OFF FORM

Crown Construction Equipment follows the general Safety Standards specified by the Society of Automotive Engineers (SAE) and the Occupational Safety and Health Administration (OSHA). Anyone who will be operating and/or maintaining the Crown Mortar Mixer must read and clearly understand ALL Safety, Operating and Maintenance information presented in this manual.

Do not operate or allow anyone else to operate this equipment until such information has been reviewed. Annually review this information before the season start-up.

Make these periodic reviews of SAFETY and OPERATION a standard practice for all of your equipment. We feel that an untrained operator is unqualified to operate this machine.

A sign-off sheet is provided for your record keeping to show that all personnel who will be working with the equipment have read and understand the information in the Operator's Manual and have been instructed in the operation of the equipment.

DISTRIBUTOR INSPECTION REPORT	SAFETY
Tire Pressure Checked	Safety Chain Attached
Wheel Bolts and All Fasteners Torqued	All Decals Installed
Mixing Elements Turn	Review Operating And
Mixing Drum Pivots	Safety Instructions
Drive Belt Tension & Pulley Alignment	
Drive Engagement Clutch Set	
Lubricate Machine	
Fill Engine Crankcase & Gearbox	
Check Fluid Levels	
Have Licensed Electrician Wire Motor & Provide Power	

3. SAFETY DECALS LOCATIONS

READ AND STUDY THE FOLLOWING SAFETY INFORMATION BEFORE ATTEMPTING TO OPERATE THIS EQUIPMENT. IN ADDITION, ENSURE THAT EVERY INDIVIDUAL WHO OPERATES OR WORKS WITH THIS EQUIPMENT IS FAMILIAR WITH THESE SAFETY PRECAUTIONS.

IT IS THE OPERATOR'S RESPONSIBILITY TO OPERATE OUR MACHINES ONLY WHEN WEARING THE PROPER PROTECTION RECOMMENDED BY THE OCCUPATIONAL SAFETY AND HEALTH ADMINISTRATION. HARM OR DEATH BY INHALING PARTICLES OR OTHER PHYSICAL INJURY MAY OCCUR IF THIS MACHINE IS OPERATED WITHOUT USING THE PROPER SAFETY GEAR, OR FOLLOWING THE APPROPRIATE PROCEDURES IN THIS MANUAL.

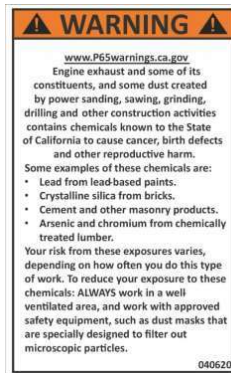

REMEMBER! It is the owner's responsibility to communicate information on the safe use and proper operation of this unit to the operators.

The types of safety signs and locations on the equipment are shown in the illustration below. Good safety requires that you familiarize yourself with the various Safety Signs, the type of warning and the area, or particular function related to that area, that requires your SAFETY AWARENESS. Think SAFETY! Work SAFELY!

REMEMBER - If Safety Signs have been damaged, removed, become illegible or parts replaced without safety signs, new signs must be applied.

New safety signs are available from your authorized dealer.



A

WARNING

ROTATING PART HAZARD KEEP AWAY

TO PREVENT SERIOUS INJURY OR DEATH ROTATING PARTS:

1. INSTALL, CLOSE AND SECURE ALL GUARDS, SHIELDS AND HOODS BEFORE OPERATING.
2. DO NOT PLACE HANDS IN DRUM UNLESS THE MOTOR OR ENGINE IS OFF AND THE POWER CORD UNPLUGGED OR THE KILL SWITCH ACTIVATED.
3. KEEP HANDS, FEET, HAIR AND LOOSE CLOTHES AWAY FROM MOVING PARTS.

201003

B

WARNING

MISSING GUARD HAZARD

INSTALL, CLOSE AND SECURE ALL GUARDS, SHIELDS AND HOODS BEFORE OPERATING.

201003

C

WARNING

IMPROPER OPERATION OF THIS EQUIPMENT CAN CAUSE SERIOUS INJURY OR DEATH. READ OPERATOR'S MANUAL SUPPLIED WITH THIS MACHINE BEFORE OPERATION OR SERVICING. MODIFICATION OR ALTERATION OF THIS MACHINE WILL VOID MANUFACTURER'S WARRANTY. DO NOT ALTER OR MODIFY THIS MACHINE WITHOUT THE EXPRESS WRITTEN CONSENT OF THE MANUFACTURER.

201154

E

WARNING

ROTATING PART HAZARD KEEP AWAY

TO PREVENT SERIOUS INJURY OR DEATH ROTATING PARTS:

1. INSTALL, CLOSE AND SECURE ALL GUARDS, SHIELDS AND HOODS BEFORE OPERATING.
2. DO NOT PLACE HANDS IN DRUM UNLESS THE MOTOR OR ENGINE IS OFF AND THE POWER CORD UNPLUGGED OR THE KILL SWITCH ACTIVATED.
3. KEEP HANDS, FEET, HAIR AND LOOSE CLOTHES AWAY FROM MOVING PARTS.

201003

D

WARNING

201005

E

CHECK LIST

- CHECK AND TIGHTEN WHEN NECESSARY ALL NUTS AND BOLTS.
- CHECK MIXER PADDLE AND WIPERS ADJUSTMENTS AND TIGHTEN PADDLE BOLTS.
- GREASE ALL FITTINGS - GREASE DRUM SEALS TO AVOID DOWN TIME ON REPAIRS.
- CHECK BELT ADJUSTMENT AND TIGHTEN BELT IF NECESSARY.
- CHECK TIRE PRESSURE. INFLATE 12" AND 13" TO 30 PSI. 8" TIRES TO 45 PSI. WHEEL LUG TORQUE MUST BE 105 LBF.
- ENSURE THE DRUM LOCK AND HOOD FASTENER ARE IN LOCKED POSITION BEFORE TRANSPORTATION.

290791

E

WARNING

ROTATING PART HAZARD KEEP AWAY

TO PREVENT SERIOUS INJURY OR DEATH ROTATING PARTS:

4. INSTALL, CLOSE AND SECURE ALL GUARDS, SHIELDS AND HOODS BEFORE OPERATING.
5. DO NOT PLACE HANDS IN DRUM UNLESS THE MOTOR OR ENGINE IS OFF AND THE POWER CORD UNPLUGGED OR THE KILL SWITCH ACTIVATED.
6. KEEP HANDS, FEET, HAIR AND LOOSE CLOTHES AWAY FROM MOVING PARTS.

201003

F

WARNING

ROTATING PART HAZARD

ALWAYS STAND CLEAR OF THE DRUM HANDLE WHEN MIXER IS IN OPERATION. ANY BINDING OF MATERIAL BETWEEN MIXER BLADES AND THE DRUM MAY CAUSE DRUM HANDLE TO QUICKLY MOVE TO THE CHARGE POSITION.

201157

G

WARNING

1. READ AND UNDERSTAND OPERATOR'S MANUAL AND SAFETY SIGNS BEFORE STARTING.
2. STOP ENGINE, DECONNECT DRIVE PULLEY WIRE AND WAIT FOR ALL MOVING PARTS TO STOP BEFORE SERVICING, MAINTAINING, ADJUSTING OR CLEANING.
3. KEEP HANDS, FEET, HAIR AND CLOTHING AWAY FROM MOVING PARTS.
4. INSTALL, CLOSE AND SECURE ALL GUARDS, SHIELDS AND HOODS BEFORE OPERATING.
5. DO NOT PLACE HANDS IN THE DRUM UNLESS ENGINE IS OFF AND DRIVE PULLEY IS DISCONNECTED OR UNPLUGGED OR POWER CORDS UNPLUGGED.
6. STAY AWAY FROM HOT ENGINE COMPONENTS DURING OPERATION.
7. STAY AWAY FROM HOT SURFACES OF ELECTRIC MOTOR.
8. DO NOT TOUCH WHEN REPLETING.
9. USE POWER CORD WITH PROPER GROUNDING TO CARRY POWER TO ELECTRIC MOTOR.
10. FOLLOW GOOD SAFETY PROCEDURES WHEN HANDLING FUEL.
11. ROUTE THE POWER CORD OUT OF THE WAY & PROTECT IT FROM DAMAGE.
12. ALWAYS WEAR SEATBELT WHEN OPERATING ON GRAVITY FEED VENTILATED AREA WITH PROPER VENTILATION.
13. KEEP WORKING AREA CLEAN AND CLEAR TO PREVENT SLIPPING AND TRIPPING.
14. ALWAYS ATTACH SAFETY CHAIN WHEN TOWING.
15. COMPLY WITH APPLICABLE TRANSPORTING REGULATIONS WHEN TOWING.
16. ALWAYS WEAR SEATBELT WHEN TRANSPORTING.
17. DO NOT EXCEED A SAFETY TRAVEL SPEED WHEN TRANSPORTING, SLOW DOWN FOR CORNERS AND WHEN GOING OVER BUMPS.

201001



H

G

USE GASOLINE FUEL ONLY

201152

J

DANGER

FIRE HAZARD NO SMOKING

TO PREVENT SERIOUS INJURY OR DEATH FROM FIRE:

1. DO NOT SMOKE WHEN REFUELING.
2. KEEP SPARKS, FLAMES, AND HOT MATERIAL AWAY FROM FLAMMABLE SUBSTANCES.

201005

L

DANGER

ELECTROCUTION HAZARD

1. DO NOT TOUCH ANY PART THAT TOUCHES OR IS CLOSE TO POWER SOURCE. UNLESS POWER CORD AND WIRE FOR MOVING PARTS TO STOP. PROTECT YOURSELF BY WEARING INSULATED RUBBER SHOES.

M

WARNING

45 mi/hr.

EXCESSIVE TOWING SPEED CAN CAUSE SERIOUS INJURIES OR DEATH.

- DO NOT EXCEED 45 MI/HR. (73 KM/HR.)
- BE CERTAIN THAT THE WHEEL LUG NUTS AND AXLE MOUNTING HARDWARE ARE TIGHTENED.
- CHECK PRESSURE AND OVERALL CONDITIONS OF TIRES.

201151

N

NOTICE

- ENSURE THE VEHICLE HAS TOWING CAPACITY FOR THE WEIGHT OF THIS MACHINE.
- DO NOT TOW MACHINE UNLESS THE DRAW BAR IS BOLTED IN PLACE AND THE SAFETY PIN IS SECURELY FASTENED.
- CLOSE ENGINE FUEL CUTOFF BEFORE TOWING MIXER TO PREVENT LEAKING OIL INTO ENGINE COMPARTMENT.
- 2-PERSON LIFT PER UNIT TO POSITION MIXER ON VEHICLE.
- SECURELY ATTACH HITCH TO TOWING VEHICLE. ENSURE USE OF SAFETY PIN THROUGH LATCH OR HANDWHEEL FOR BALL TYPE HITCH. SAFETY CHAIN ATTACHMENT (SEE PICTURE) MUST CROSS UNDER THE DRAW BAR AND BE POSITIONED TO PREVENT THE DRAW BAR FROM DRIPPING TO THE GROUND IN THE EVENT OF HITCH FAILURE.
- CONNECT LIGHTING PLUG/ELECTRIC BRAKE PLUG (WHEN APPLICABLE).
- MAKE CERTAIN THAT THE WHEEL LUG NUTS AND AXLE MOUNTING HARDWARE IS TIGHTENED.
- CHECK PRESSURE AND OVERALL CONDITION OF TIRES.
- TEST BREAKS (IF APPLICABLE).

201150

P

CAUTION

2-PERSON LIFT REQUIRED TO POSITION MIXER HITCH ON/OFF VEHICLE

201155

4 OPERATION

4.1 TO THE NEW OPERATOR OWNER

The Crown Construction Equipment Mortar Mixer is designed to efficiently combine water, lime, aggregate and cement into a mixture for forming mortar. It is the responsibility of the operator to be familiar with the machine before starting.

It is the responsibility of the owner or operator to read this manual before starting. Follow all safety instructions exactly. Safety is everyone's business. By following recommended procedures, a safe working environment is provided for the operator, bystanders and the environment.

Many features incorporated into this machine are the result of suggestions made by customers like you. Read this manual carefully to learn how to operate the machine safely and how to set it to provide maximum mixing efficiency. By following the operating instructions in conjunction with a good maintenance program, your Mixer will provide many years of trouble-free service.

4.2 HOW THE MACHINE WORKS

The Mortar Mixer consists of a large tilting drum with internal rotating paddles or spiral blades for combining cement, lime, aggregate and water into a mixture for forming mortar. The enclosure on the back end houses the electric motor or gas engine for turning the mixing elements. A set of pulleys and drive belt within the enclosure transmits rotational power to a gearbox that powers the mixing elements.

A lever on the front end of the drum assembly allows the operator to tilt the drum to the required position for mixing and emptying. A lever on the bottom of the frame extends to the power compartment and moves

the gearbox to engage the drive belt for turning the mixing elements. An extendable hitch allows the hitch to extend for towing and retracts during operation.



B: When is electric

REMEMBER! ALWAYS USE PERSONAL SAFETY EQUIPMENT.

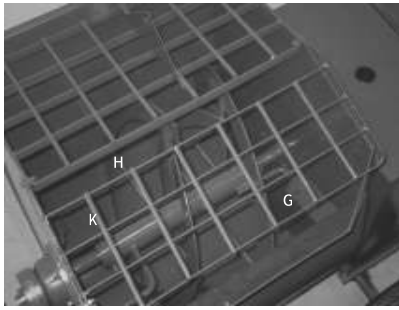

Fig. 1 MACHINE COMPONENTS

- | | |
|---------------------|---------------------|
| A Gas Engine | J Bag Splitter |
| B Electric Motor | K Drum |
| C Belt/Pulley Drive | L Tilt Lever |
| D Gearbox | M Drum Lock |
| E Power Compartment | N Engagement Clutch |
| F Paddles | O Hitch |
| G Spiral Blades | P Safety Chain |
| H Grill | Q Emergency Stop |



4.3 PRE-OPERATION CHECKLIST

Efficient and safe operation of the Mixer requires that each operator reads and understands the operating procedures and all related safety precautions outlined in this section. A pre-operation checklist is provided for the operator. It is important for both personal safety and maintaining the good mechanical condition of the machine that this checklist is followed.

Before operating the Mixer and each time there-after, the following areas should be checked off:

1. Gas Engine Units:
 - a. Check all fluid levels: fuel, engine oil and gearbox oil. Refuel or top up oil as required.
 - b. Check the tires and be sure that they are inflated to the specified pressure.
 - c. Check the tension and alignment of drive belt when engaged. Tension or align as required.
 - d. Check the engine speed at maximum. Be sure it is set to give a paddle rotation speed of 30-35 RPM and a spiral rotation of 40-45 RPM.
 - e. Use the emergency stop switch to stop the engine to be sure that it works. Repair or replace if it is not functioning.
 - f. Lubricate machine per Maintenance Section.
 - g. Close and secure all guards, shields and hoods.
2. Electric motor units:
 - a. Check the tension and alignment of drive belt when engaged. Tension and align as required.
 - b. Check gearbox oil level. Top up as required.
 - c. Check the tires and be sure that they are inflated to the specified pressure.
 - d. Lubricate machine per Maintenance Section.
 - e. Close and secure all guards, shields and hoods.

4.4 PRE-START PROCEDURES

All machines are sent from the factory in a special shipping configuration to prevent spilling oil or gas. As a result, the following items must be done prior to starting the machine:

1. Gas engine powered units:
 - a. Fill the engine crankcase with its specified oil (SAE 30W or 10W30 oil).
 - b. Add SAE 80W90 oil to the gearbox.
 - b.1 New style gearbox (after 2019): 0.88 gal (4 lts)
 - b.2 Old style gearbox (before 2019): 0.25 gal (1 lt)
 - c. Fill the fuel tank with regular unleaded gas. Do not use an ethanol blend.
 - d. Start the engine and set the high idle speed to give a mixing element rotation speed of 30 to 35 RPM for the paddles and 40 to 45 for the spiral.

IMPORTANT
Engine warranty is void if the engine is run without oil.

Refer to engine manual for oil specifications if operating in unusual temperature conditions.

IMPORTANT
The engine is supplied from the engine manufacturer with the high idle speed set at approximately 3500 RPM and no gas or oil. As a result, the engine is not run when it is mounted to the Mixer. It is the responsibility of the customer to add oil and gas, start the engine and reset the high idle RPM to the operating range (Refer the Maintenance Section for procedure).

- e. The machine is shipped with the drum tilt lever pointing down or fastened to the safety grill. Remove lever and turn it around so it is pointing up. Tighten mounting bolts to their specified torque.
- f. Be sure the emergency stop switch is functioning properly.

2. Electric motor-powered units:

- a. Have a licensed electrician provide power to the motor. Use only a grounded cord with sufficient capacity to carry the required load.
- b. Have a licensed electrician wire up the motor if it is not a 110-volt unit.
- c. The machine is shipped with the drum tilt lever pointing down. Remove lever and turn it around so it is pointing up. Tighten mounting bolts to their specified torque.

4.4 MACHINE BREAK-IN

A special break-in procedure has been developed to ensure the integrity of the machine when first starting. When using the machine for the first time, follow this procedure.

A. Before Starting:

1. Read the engine and Mixer Operator's Manuals.
2. Review and follow pre-start procedures before starting machine (Section 4.4).

B. At 1/2, 2, 5 and 10 hours:

1. Check all machine fluid levels: Fuel, engine oil and gearbox oil. Refuel or top up as required.
2. Retorque wheel bolts.
3. Check for loose hardware. Tighten to specified torque.
4. Check drive belt tension and alignment when engaged. Tension and align as required.
5. Lubricate the points defined in the Maintenance section.
6. Then go to the service schedule as defined in the Maintenance section.

C. At 10 hours:

1. Change the engine oil.
2. Change the gearbox oil.
3. Replace with their specified oil.
4. Then go to the oil replacement schedule as defined in the Maintenance section and engine manual.

**REMEMBER! ALWAYS USE
PERSONAL SAFETY
EQUIPMENT.**

4.5 CONTROLS

Before starting to work, all operators should familiarize themselves with the location and function of the controls.

1. Gas engine powered units:

Always read the engine Operator's Manual supplied with the machine for the detailed operating procedures for your engine.

a. Ignition switch:

This switch controls the electrical power to the engine electrical system. Turn the switch clockwise to turn the electrical system ON and the engine will run. Turn counterclockwise to stop the engine.

b. Fuel shutoff valves:

Each engine is equipped with a shut-off valve between the fuel tank and the carburetor.

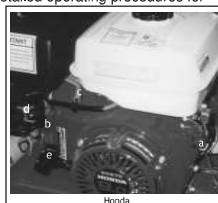

Slide the fuel valve toward the block to turn ON and away for OFF. Turn the fuel OFF when not in use or before transporting.

c. Throttle:

This lever controls the engine RPM. Move the lever laterally to increase or decrease the RPM. Always run at maximum throttle operating.

d. Choke:

The choke controls the fuel/air mixture to the engine. Close the choke when starting if the engine is cold. Open the choke as the engine warms. Always open the choke fully during operation.

e. Starting rope:

This retracting rope and T bar is used to turn the engine over for starting. Grasp the T bar firmly and pull the rope sharply to start the engine.

Close the choke if the engine is cold.

f. External Emergency Stop Switch:

This push-pull switch shorts out the power to the gas engine ignition system and is located on the outside of the hood. Push the switch in to stop the engine and pull out to allow it to run.



2. Electric Motor (Typical):

a. Master ON/OFF:

This switch controls the power to the electric motor that turns the mixing elements in the drum. Move the switch rearward to turn ON and forward for OFF.

2. Drum Position:

This lever sets the position of the mixing drum. Move the lever down to empty the drum and up to mix.

3. Drum Position Lock:

This lever locks the mixing drum in its mixing position. Pull up on lever to release the lock. It will automatically engage when the drum is moved into its mixing position.

4. Drum Position Lock: This lever locks the mixing drum in its mixing position. Pull up on lever to release the lock. It will automatically engage when the drum is moved into its mixing position.

5. Drive Engagement Clutch: This lever engages and disengages the mixing elements in the drum. Move to the left to disengage the drive and ease to the right to engage. Always disengage before starting the engine or motor.

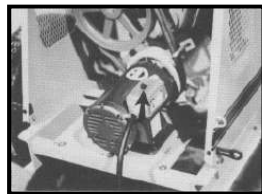

REMEMBER! It is the owner's responsibility to communicate information on the safe use and proper operation of this unit to the operators.

4.6 OPERATING SAFETY



OPERATING SAFETY

1. Read and understand the Operator's Manual and all safety signs before operating, servicing, adjusting, or cleaning the Mixer.
2. Do not allow riders on the machine during transport.
3. Install, close and secure all guards, shields and hoods before starting or operating.
4. Stop engine or motor, disconnect spark plug wire or unplug power cord, and wait for all moving parts to stop before servicing, adjusting, repairing, or cleaning.
5. Clear the area of all bystanders before starting.
6. Keep hands, feet, hair and clothing away from moving parts.
7. Keep working area clean and dry to prevent slipping and tripping.
8. Do not run the mixer in an explosive atmosphere or in a poorly ventilated or enclosed area.
9. Wear appropriate hearing protection when operating for long periods of time.
10. Always attach safety chain when towing.
11. Do not exceed a safe travel speed when towing. Slow down for corners and when going over rough terrain.
12. Review safety instructions with all operators annually.

Gas engine powered units:

- Do not place hands in the drum unless the engine is OFF and the spark plug wire is disconnected.
- Stay away from hot engine components during operation.
- Do not smoke when refueling gas engine.

Electric motor-powered units:

- Do not place hands in the drum unless the motor is OFF and the power cord unplugged.
- Have a licensed electrician wire up and provide power to the motor. • Only use a power cord that is grounded. • Always use an electrical cord with the required power carrying capacity.

Each operator should review this section of the manual when starting a project and as often as required to be familiar with the machine. When operating, follow this procedure:

1. Review and follow the Pre-Start and Pre-Operation checklists.
2. Review the location and function of all controls.
3. Determine ratio of the cement, lime, water and aggregate required for your mixture. Always use the same mixture ratio for each batch.
4. Be sure the mixing elements turn at 30 to 35 RPM for the paddles and 40 to 45 RPM for the spiral to insure proper mixing.
5. Starting machine:

A. Electric motor-powered units:

- a. Check that everyone is clear of the machine.
- b. Move power engagement clutch to the left to disengage the mixing elements.
- c. Unlatch and open the hood.
- d. Turn the power switch ON.
- e. Close and latch the hood.

- f. Add half the required amount of sand into the drum.
- g. Add the required mortar mix (cement, lime, etc.).
- h. Add the cement required for the batch.
- i. Add the rest of the water.
- j. Add the rest of the sand until the desired workability is obtained.
- k. Mix until there is an even consistency throughout the mixture. Look into the drum and watch until the mixture is the same color throughout. This means the mortar mix is evenly distributed throughout the mixture.
- l. Disengage the mixing clutch.
- m. Release the drum lock and slowly tilt the drum down to discharge the mixture.
- n. Raise the hinged grill out of the way when discharging the mixture.
- o. Move the drum back into its mixing position and lock. Immediately engage the mixing clutch and add half the water for the next batch. This will help to keep the drum and mixing elements clean and prevent lumps from forming in the mortar

10. Mixing Time

After all the ingredients have been added to the drum, allow time for the material to reach a uniform color and consistency. Watch the color and consistency of the mixture as the drum is turning. When the entire mixture becomes a pale green color, it means the mortar mix is uniformly distributed throughout the mixture and can be discharged. If the mixture is not uniform, the mortar will have weak spots.

11. Emptying drum:

All Mixers are equipped with a lock for anchoring the drum at the mixing angle. Move the wheelbarrow or other mortar receiver up to the side of the Mixer.

To empty the drum:

- a. Disengage mixing clutch.
- b. Release drum lock.
- c. Move the wheelbarrow into position.
- d. Slowly tilt the drum down.
- e. Lift the hinged grill out of the way.
- f. Fill the wheelbarrow.
- g. Raise the drum back into its mixing position and lock.
- h. Engage mixing clutch.
- i. Add half the water and sand for the next batch to clean elements from drum.



12. Mixing Elements:

A Mixer can be equipped with paddles or a spiral for mixing the materials into a uniform mixture. Each system has adjustable wipers to clean the sides and ends of the drum. Maintain the wipers at 1/16 to 1/8 inch (1.5 to 3.0 mm) from the drum surface. A large gap can result in a build-up on the surface. This build-up will break loose and produce lumps or chips in the mixture.

13. Preventing Build-up:

To maintain high quality mixing, consistent performance and machine life, thoroughly clean the mixer inside and out at the end of each day.

- f. Move power engagement clutch to the right to engage the mixing elements.

B. Gas engine powered units:

- a. Check that everyone is clear of the machine.
- b. Pull the emergency stop switch out.
- c. Move power engagement clutch to the left to disengage the drive.
- d. Unlatch and open the engine compartment hood.
- e. Move the throttle into its midrange position.
- f. Close the choke if starting when the engine is cold.
- g. Turn the ignition switch to its RUN position.
- h. Pull sharply on the T bar rope to start the engine.
- i. Allow the engine to run for a couple of minutes to warm up.
- j. Open the choke to its fully open position when the engine is warm.
- k. Move the throttle to its maximum RPM position.
- l. Close and secure the engine compartment hood.
- m. Ease the power engagement clutch to the right to engage the mixing elements

IMPORTANT

Be sure the engine has been set to give a mixing element speed of 30 to 35 RPM for the paddles and 40 to 45 RPM for the spiral.

6. Stopping machine:

C. Electric motor-powered units:

- a. Move the power engagement clutch to the left to disengage the mixing elements.
- b. Empty the drum of the mortar mixture.
- c. Unlatch and open the hood.
- d. Turn the power switch OFF.
- e. Close and latch the hood.

D. Gas engine powered units:

- a. Move the power engagement clutch to the left to disengage the mixing elements.
- b. Empty the drum of the mortar mixture.
- c. Unlatch and open the hood.
- d. Move the throttle to its lowidle position.
- e. Stop the engine by turning the switch OFF or depressing the kill switch or strap.
- f. Close and secure the engine compartment hood.

7. Emergency Stopping:

If an emergency arises, stop the machine by moving the power engagement clutch to the left to disengage the mixing elements and then pushing the kill switch in.

8. Machine placement:

Always place the Mixer in a location so the operator has easy access to the mixture ingredients when adding to the mixing drum. Always position to provide adequate clearance for the machine or equipment removing the concrete mixture from the mixing drum. On the electric motor models, route the power cord out of the way to prevent damage. Do not run the mixture in an explosive atmosphere or in a poorly ventilated or enclosed area.

9. Filling

When mixing mortar, follow this procedure:

- a. Clear the working area of unauthorized personnel.
- b. Start the motor or engine.
- c. Engage the mixing elements.
- d. Add half the required amount of water into the mixing drum.

Add sand and water until the desired consistency is obtained.

NOTE

The Mixer is equipped with a solid grill and bag splitter over the drum opening. Place the bag of material on the grill/splitter and let the material fall into the drum. Repeat with the next bag until the required amount is added.

Under normal operating conditions, adding water and sand and some aggregate to the drum immediately after emptying will wash and clean the mixing elements and the inside of the drum and keep them clean providing the wipers are set at 1/16 to 1/8 inch (1.5 to 3 mm) from the drum surface. If a slow build-up is occurring, add water and coarse sand to the drum at the end of the working day and let it run for 15 minutes.

14. Removing Build-up:

Always disable the machine by unplugging the power cord or disconnecting the spark plug wire. Dried mix should be scraped out as necessary. DO NOT strike the outside of the drum with a shovel, hammer or other device to break up and loosen any build-up, as this will dent and damage the drum. At the end of the working day, thoroughly wash the inside of the drum and the outside of the machine to remove any residue build-up or clumps. Do not get water on the electric motor or gas engine.

15. Drum speed:

The best mixing action occurs when the mixing elements are turning 30 to 35 RPM for the paddles and 40 to 45 for the spiral. Do not operate outside of this speed range. Increasing the mixing element speed does not significantly change mixing characteristics. Mixing time is much more important and the mixture must be thoroughly blended to obtain uniform and consistent mortar.

16. Capacities:

Each model has its own specified capacity. When that capacity is exceeded, the excess spills out of the drum making a mess of the working area and increases the required time for mixing. It is recommended to use an additional mixer if more mixing capacity is required.

17. Power engaging clutch

Power Engaging Clutch: The power engaging clutch lever is located next to the drum tilting controls so it is convenient for the operator to stop the mixing elements when emptying the drum. The linkage in the power compartment must be set so the drive belt does not slip during operation and the operator must feel the lever go over-center as it fully engages. Always disengage the clutch when starting, stopped or emptying.

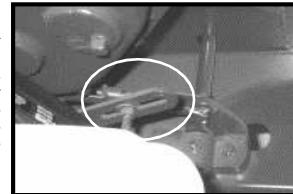

18. Selection of Mortar type:

The performance of masonry is influenced by various mortar properties such as workability, bond strength, durability, extensibility and compression strength. Since these properties vary with mortar type, it is highly important that the mortar type selected for a particular application is the one that best meets the end-user requirements. Table 1 is a general guide for the selection of for various masonry wall construction. Selection of mortar type should also be based on the type of masonry units to be used as well as the applicable building code and engineering practice standard requirements such as allowable design stresses and lateral support.

19. Guide for the selection of masonry Mortars

TABLE 1 MORTAR TYPE:

Location	Building Segment	Recommended Alternative	
Exterior, above grade	Loadbearing wall	N	S or M
	Non-loading wall, Parapet wall, chimney & veneer wall	N	O ^a or S
		N	S
Exterior, at or below grade	Foundation wall, retaining wall, manholes, sewers pavements walks and patios	M	S ^a or N ^a
Interior	Loadbearing wall	N	S or M
	Non loadbearing partitions.	O	N

A This table does not provide for many specialized mortars used, such as reinforced masonry, acid resistant and fire box mortars.
B Type O mortar is recommended for use where the masonry is unlikely to be frozen when saturated or unlikely to be subject to high winds or other significant lateral loads. Type N or S mortar should be used in other cases.
C Masonry exposed to weather in a nominally horizontal surface is extremely vulnerable to weathering. Mortar for such masonry should be selected with due caution.

TABLE 3 PROPERTY SPECIFICATION REQUIREMENTS

Mortar type	Average compressive strength at 28 days, min psi (MPa)	Water retention min %	Air content max %	Aggregate ratio (measured in damp loose conditions)
M	2500 (17.2)	75	12	Not less than 2 1/4 and not more than 3 1/2 times the sum of the separate volumes of cementitious materials.
S	1800 (12.4)	75	12	
N	750 (5.2)	75	14	
O	350 (2.4)	75	14	

20. Volumes & weights of materials

1 Bag of Cement	88 lb.	1 Bag of Cement	40 Kg
1 Cu. ft. Sand/Gravel	85-100 lb.	1 cu. meter Sand/Gravel	1360-1600 Kg
1 Cu. ft. Plain Concrete	140-150 lb.	1 cu. meter Plain Concrete	2240-260 Kg
1 Cu. ft. Water	62-65 lb.	1-liter Water	1 kg
1 Imperial Gallon of Water	10 lb.	1 cu. meter Water	1000 kg
1 Cu. Yard		27 cu. ft. = 7646 cu. mt	

21. Operating hints:

- Keep the working area as clean and dry as possible to prevent slipping and tripping.
- Provide sufficient space around the machine for adding material to the drum and removing the mixture.
- Always add the materials in the same ratio to give a uniform mixture for mortar.
- Provide sufficient time to thoroughly combine the mixture to a uniform consistency before discharging from the drum.
- The water requirements for the mixture can vary depending on moisture content of the sand. Vary the amount of water in the mixture to give the consistency of the mortar desired.

4.7 TRANSPORTING

Crown Construction Mixers are designed to be easily and conveniently moved from place to place.

When moving the machine, follow this procedure:

- On the larger Models, extend the pole to its full length.
- Secure with the lock pin and retainer.
- Use 2 men to lift the hitch and pull the Mixer to the new location.
- Retract and lock the pole.
- When transporting the machine, follow this procedure:
 - On the electric motor-powered units, unplug the power cord.
 - On gas engine powered units, open the hood and close the fuel valve to prevent flooding the carburetor.
 - Move the drum to its mixing position and lock.
 - Attach the optional lighting bar and secure.
 - On the larger Models, extend the hitch pole and secure with the lock pin and retainer.
 - Securely attach the machine to the towing vehicle.
 - Use a mechanical retainer through the ball hitch or the clevis pin.

FUEL SHUT OFF VALVE



TRANSPORT SAFETY

- Read and understand ALL the information in the Operator's Manual regarding procedures and SAFETY when operating the Mixer in the workplace and/or on the road.
- Always travel at a safe speed. Use caution when making corners or on a rough surface.
- Make sure all the lights and reflectors that are required by the local highway and transport authorities are in place, are clean and can be seen clearly by all overtaking and oncoming traffic.
- Do not allow riders on any part of the machine during either road or highway travel.
- Always use a safety chain between the Mixer and the towing vehicle when transporting.
- Use a mechanical retainer through the ball hitch or clevis pin before transporting.
- Ensure wheel nuts and axle hardware are tight.

DRUM COMPLETELY RAISED



- Attach the safety chain to prevent unexpected separation. Cross the chains under the hitch for support.
- Plug the wiring harness into the truck. Be sure all the lights are working.
- Check that the wheel bolts are tightened to their specified torque.
- Check that the tires are inflated to their required pressure.
- Use special care when transporting during times of limited visibility. Be sure that you can be seen by oncoming and overtaking traffic. Always use the lighting bar.
- Never exceed the speed appropriate for the terrain and conditions. Slow down for turns and when traveling over rough terrain.



Be sure the ball on the truck is the correct size for the hitch. Do not use an undersized ball with the hitch.



4.8 STORAGE

STORAGE SAFETY

- Store unit in an area away from human activity.
- Do not permit children to play on or around the stored Mixer.

At the end of the season or when the machine will not be used for a period, inspect all major components of the Mixer. Repair or replace any worn or damaged components to prevent any unnecessary down time at the start of next project. When preparing for storage, follow this procedure:

- Drain the fuel from gas tank.
- Turn the fuel supply valve OFF or unplug the power cord.
- Close and secure the hood.
- Thoroughly wash the machine using a water hose or pressure washer to remove all dirt, dust or residue.
- Inspect the inside of the drum. Chip out or break lose any build-up.
- Lubricate all the grease fittings.
- Rotate the drum so it is pointing straight down or in its emptying position.
- Cover the machine with a tarpaulin and tie down if the machine is not stored inside.

IMPORTANT

Do not get water on the electric motor or gas engine. Use an air hose to clean the motor or engine.

MAINTENANCE SAFETY

- Review the Operator's Manual and all safety items before working with, maintaining or operating the Mixer.
- Stop engine or motor, disconnect spark plug wire or unplug power cord, and wait for all moving parts to stop before servicing, adjusting, repairing, or cleaning.
- Follow good shop practices: Keep service area clean and dry. Be sure electrical outlets and tools are properly grounded. Use adequate light for the job at hand.
- Keep hands, feet, clothing and hair away from all moving and/or rotating parts.
- Do not place hands in the drum unless the engine is off and the spark plug wire is disconnected or the power cord is unplugged.
- Do not attempt any adjustment or maintenance to any system of the Mixer unless the power source is disabled.
- Make sure that all guards, shields and hoods are properly installed and secured before operating the Mixer.
- Securely support the machine using blocks or safety stands before working beneath it or changing tires.
- Store and transfer gasoline, solvents, cleaners or any flammable liquids only in safety standard approved containers.

5. SERVICE

5.1 SERVICE & MAINTENANCE

5.1.1 FLUIDS & LUBRICANTS

- Grease
 - Use an SAE multi-purpose high temperature grease or a multi-purpose lithium base grease.
- Gasoline
 - Use a standard unleaded gasoline for all operating conditions.
 - Do not use gasoline with an ethanol blend.

Capacities:
5.5 Honda: 0.95 US Gal (3.6 lts, 0.79 Imp Gal)



