

STIHL FS 311

Instruction Manual
Manual de instrucciones



⚠ WARNING
Read Instruction Manual thoroughly before use and follow all safety precautions – improper use can cause serious or fatal injury.

⚠ ADVERTENCIA
Antes de usar la máquina lea y siga todas las precauciones de seguridad dadas en el manual de instrucciones – el uso incorrecto puede causar lesiones graves o mortales.



English

English

Guide to Using this Manual

Pictograms

The meanings of the pictograms attached to or embossed on the machine are explained in this manual. Depending on the model concerned, the following pictograms may be on your machine.

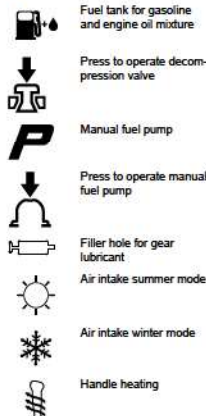

Symbols in Text

Many operating and safety instructions are supported by illustrations.

The individual steps or procedures described in the manual may be shown in different ways:

- A bullet indicates a step or procedure.

A description of a step or procedure that refers directly to an illustration may contain item numbers that appear in the illustration. For example:

- Remove the screw (1)
- Pull the spark arresting screen (2) upwards out of the muffler

In addition to the operating instructions, this manual may contain paragraphs that require your special attention. Such paragraphs are indicated with the symbols and signal words described below:

⚠ DANGER

Indicates a hazardous situation that, if not avoided, will result in death or serious injury.

⚠ WARNING

Indicates a hazardous situation that, if not avoided, could result in death or serious injury.

NOTICE

Indicates a risk of property damage, including damage to the machine or its individual components.

Engineering Improvements

STIHL's philosophy is to continually improve all of its products. As a result, engineering changes and improvements are made from time to time. Therefore, some changes, modifications and improvements may not be covered in this manual. If the operating characteristics or the appearance of your machine differs from those described in this manual, please contact your STIHL dealer or the STIHL distributor for your area for assistance.

Contents

Guide to Using this Manual	2	STIHL Incorporated Federal Emission Control Warranty Statement	46	Allow only persons who fully understand this manual to operate your trimmer / brushcutter.
Approved Combinations of Cutting Attachment, Deflector, Limit Stop and Harness	18	STIHL Incorporated California Exhaust and Evaporative Emissions Control Warranty Statement	48	To receive maximum performance and satisfaction from your STIHL trimmer / brushcutter, it is important that you read, understand and follow the safety precautions and the operating and maintenance instructions in chapter "Safety Precautions and Working Techniques" before using your trimmer / brushcutter. For further information you can go to www.stihlusa.com .
Mounting the Bike Handle	20	Trademarks	50	Contact your STIHL dealer or the STIHL distributor for your area if you do not understand any of the instructions in this manual.
Adjusting the Throttle Cable	21			⚠ WARNING Because a trimmer / brushcutter is a high-speed cutting tool some special safety precautions must be observed to reduce the risk of personal injury. Careless or improper use may cause serious or even fatal injury.
Mounting the Deflector	21			Make sure your unit is equipped with the proper deflector or limit stop, handle and harness for the type of cutting attachment being used. Always wear proper eye protection.
Mounting the Cutting Attachment	22			
Fuel	26			
Fueling	28			
Fitting the Full Harness	29			
Balancing the Machine	30			
Starting / Stopping the Engine	30			
Transporting the Unit	32			
Operating Instructions	34			
Replacing the Air Filter	34			
Engine Management	34			
Adjusting the Carburetor	35			
Spark Arresting Screen in Muffler	35			
Spark Plug	36			
Storing the Machine	37			
Sharpening Metal Cutting Blades	37			
Maintaining the Mowing Head	38			
Maintenance and Care	40			
Main Parts	42			
Specifications	44			
Maintenance and Repairs	45			
Disposal	45			
Limited Warranty	45			

Safety Precautions and Working Techniques

Because a clearing saw is a high-speed, fast-cutting power tool sometimes equipped with sharp cutting blades, special safety precautions must be observed to reduce the risk of personal injury.

It is important that you read, fully understand and observe the following safety precautions and warnings. Read the instruction manual and the safety precautions periodically. Careless or improper use may cause serious or fatal injury.

The terminology utilized in this manual when referring to the power tool reflects the fact that different types of cutting attachments may be mounted on it. The term "trimmer" is used to designate an FS unit that is equipped with a nylon line head or a head with flexible plastic blades (i.e., the PolyCut head). A "brushcutter" designates a unit equipped with a rigid metal blade. Many FS models may be used as either a trimmer or a brushcutter – therefore, the power tool is referred in this manual as a "trimmer / brushcutter". Some smaller and / or lightweight FS models may only be used as a trimmer, i.e., they may not be used with metal blades.

The term "clearing saw" indicates a high-powered trimmer / brushcutter that is particularly suited for use with a circular saw blade to clear saplings or small trees.

⚠ WARNING

As more fully explained later in these Safety Precautions, to reduce the risk of personal injury, make sure your unit is equipped with the proper deflector, limit stop and harness for the type of cutting attachment you are using. Use only cutting attachments that are specifically authorized by STIHL for use on your FS model.

Have your STIHL dealer show you how to operate your power tool. Observe all applicable local safety regulations, standards and ordinances.

⚠ WARNING

Do not lend or rent your power tool without the instruction manual. Be sure that anyone using it understands the information contained in this manual.

⚠ WARNING

The use of this machine may be hazardous. If the rotating line or blade comes in contact with your body, it will cut you. When it comes in contact with solid foreign objects such as rocks or bits of metal, it may fling them directly or by ricochet in the direction of bystanders or the operator. Striking such objects could damage the cutting attachment and may cause blades to crack, chip or break. Thrown objects, including broken heads or blades, may result in serious or

fatal injury to the operator or bystanders. STIHL does not recommend the use of rigid blades when cutting in stony areas.

Use your clearing saw equipped with the appropriate cutting attachment only for cutting grass, brush, wood and similar material.

⚠ WARNING

Do not use it for other purposes, since misuse may result in personal injury or property damage, including damage to the machine.

⚠ WARNING

Minors should never be allowed to use this power tool. Bystanders, especially children, and animals should not be allowed in the area where it is in use.

⚠ WARNING

To reduce the risk of injury to bystanders and damage to property, never let your power tool run unattended. When it is not in use (e.g. during a work break), shut it off and make sure that unauthorized persons do not use it.

Most of these safety precautions and warnings apply to the use of all STIHL clearing saws. Different models may have different parts and controls. See the appropriate section of your instruction manual for a description of the controls and the function of the parts of your model.

Safe use of a clearing saw involves

1. the operator
2. the power tool
3. the use of the power tool.

English

English

THE OPERATOR

Physical Condition

You must be in good physical condition and mental health and not under the influence of any substance (drugs, alcohol, etc.) which might impair vision, dexterity or judgment. Do not operate this machine when you are fatigued.

⚠ WARNING

Be alert – if you get tired, take a break. Tiredness may result in loss of control. Working with any power tool can be strenuous. If you have any condition that might be aggravated by strenuous work, check with your doctor before operating this machine.

⚠ WARNING

Prolonged use of a power tool (or other machines) exposing the operator to vibrations may produce whitefinger disease (Raynaud's phenomenon) or carpal tunnel syndrome.

These conditions reduce the hand's ability to feel and regulate temperature, produce numbness and burning sensations and may cause nerve and circulation damage and tissue necrosis.

All factors which contribute to whitefinger disease are not known, but cold weather, smoking and diseases or physical conditions that affect blood vessels and blood transport, as well as high vibration levels and long periods of

exposure to vibration are mentioned as factors in the development of whitefinger disease. In order to reduce the risk of whitefinger disease and carpal tunnel syndrome, please note the following:

- Most STIHL power tools are available with an anti-vibration ("AV") system designed to reduce the transmission of vibrations created by the machine to the operator's hands. An AV system is recommended for those persons using power tools on a regular or sustained basis.
- Wear gloves and keep your hands warm.
- Keep the AV system well maintained. A power tool with loose components or with damaged or worn AV elements will tend to have higher vibration levels.
- Maintain a firm grip at all times, but do not squeeze the handles with constant, excessive pressure. Take frequent breaks.

All the above-mentioned precautions do not guarantee that you will not sustain whitefinger disease or carpal tunnel syndrome. Therefore, continual and regular users should closely monitor the condition of their hands and fingers. If any of the above symptoms appear, seek medical advice immediately.

⚠ WARNING

The ignition system of the STIHL unit produces an electromagnetic field of a very low intensity. This field may interfere with some pacemakers. To reduce the risk of serious or fatal injury, persons with a pacemaker should

consult their physician and the pacemaker manufacturer before operating this tool.

Proper Clothing

To reduce the risk of injury, the operator should wear proper protective apparel.

⚠ WARNING

The deflector provided with your power tool will not protect the operator from all foreign objects (gravel, glass, wire, etc.) thrown back by the rotating cutting attachment. Thrown objects may also ricochet and strike the operator.

FS 311

3

4

FS 311

⚠ WARNING

To reduce the risk of injury to your eyes never operate your power tool unless wearing goggles or properly fitted protective glasses with adequate top and side protection complying with ANSI Z87 "+" (or your applicable national standard). To reduce the risk of injury to your face STIHL recommends that you also wear a face shield or face screen over your goggles or protective glasses.

Wear an approved safety hard hat to reduce the risk of injury to your head when there is a danger of head injuries.

Power tool noise may damage your hearing. Wear sound barriers (ear plugs or ear muffs) to protect your hearing. Continual and regular users should have their hearing checked regularly.

Be particularly alert and cautious when wearing hearing protection because your ability to hear warnings (shouts, alarms, etc.) is restricted.



Always wear heavy duty work gloves (e.g. made of leather or other wear resistant material) when handling the machine and metal blades. Heavy-duty, nonslip gloves improve your grip and help to protect your hands.



Clothing must be sturdy and snug-fitting, but allow complete freedom of movement. Wear long pants made of heavy material to help protect your legs. Do not wear shorts, sandals or go barefoot.

Avoid loose-fitting jackets, scarfs, neckties, jewelry, flared or cuffed pants, unconfined long hair or anything that could become caught on branches, brush or the moving parts of the unit. Secure hair so it is above shoulder level.



Good footing is very important. Wear sturdy boots with nonslip soles. Steel-toed safety boots are recommended.

THE POWER TOOL

For illustrations and definitions of the power tool parts see the chapter on "Main Parts."

⚠ WARNING

Never modify this power tool in any way. Only attachments supplied by STIHL and expressly approved by STIHL for use with the specific STIHL model are authorized. Although certain unauthorized attachments are useable with STIHL power tools, their use may, in fact, be extremely dangerous. For the cutting attachments authorized by STIHL for your unit, see the chapter "Approved Combinations of Cutting Attachment, Deflector, Limit Stop and Harness" in the instruction manual or the STIHL "Cutting Attachments, Parts & Accessories" catalog.

If this tool is subjected to unusually high loads for which it was not designed (e.g. heavy impact or a fall), always check that it is in good condition before continuing work. Check in particular that the fuel system is tight (no leaks) and that the controls and safety devices are working properly. Do not continue operating this machine if it is damaged. In case of doubt, have it checked by your STIHL servicing dealer.

THE USE OF THE POWER TOOL

Transporting the Power Tool

⚠ WARNING

To reduce the risk of injury from loss of control and blade or line contact, never carry or transport your power tool with the cutting attachment moving.

English

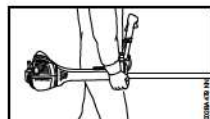

It may be carried only in a horizontal position. Grip the shaft in a manner that the machine is balanced horizontally. Keep the hot muffler away from your body.

⚠ WARNING

To reduce the risk of burn injury, do not touch hot parts of the machine and the gear housing when they are hot.

⚠ WARNING

Always shut off the engine and make sure the cutting attachment has stopped before putting a clearing saw down. When transporting it in a vehicle, properly secure it to prevent tumover, fuel spillage and damage to the unit. STIHL recommends that you keep metal blades covered with the transport guard (optional accessory).

Fuel

Your STIHL power tool uses an oil-gasoline mixture for fuel (see the "Fuel" chapter in this instruction manual).

⚠ WARNING

Gasoline is an extremely flammable fuel. If spilled and ignited by a spark or other ignition source, it can cause fire and serious burn injury or property damage. Use extreme caution when handling gasoline or fuel mix. Do not smoke or bring any fire or flame near the fuel or the power tool. Note that combustible fuel vapor may escape from the fuel system.

Fueling Instructions

⚠ WARNING

To reduce the risk of fire and serious personal injury, always place the power tool on the ground before attempting to fuel the machine.

⚠ WARNING

To reduce the risk of fire and explosion, your power tool in a well-ventilated area, outdoors away from flames, pilot lights, heaters, electric motors, and other sources of ignition. Vapors can be ignited by a spark or flame many feet away. Select bare ground for fueling and

Pick a Safe Location

To reduce the risk of fire and explosion, your power tool in a well-ventilated area, outdoors away from flames, pilot lights, heaters, electric motors, and other sources of ignition. Vapors can be ignited by a spark or flame many feet away. Select bare ground for fueling and

move at least 10 feet (3 m) from the fueling spot before starting the engine. Wipe off any spilled fuel before starting your power tool. Take care not to get fuel on your clothing. If this happens, change your clothing immediately.

Allow the Power Tool to Cool Before Removing the Fuel Cap

⚠ WARNING

Gasoline vapor pressure may build up inside the fuel tank. The amount of pressure depends on a number of factors such as the fuel used, altitude and temperature. To reduce the risk of burns and other personal injury from escaping gas, vapor and fumes, always shut off the engine and allow it to cool before removing the fuel cap.

The engine is air cooled. When it is shut off, cooling air is no longer drawn across the cylinder and engine temperatures will rise for several minutes before starting to cool. In hot environments, cooling will take longer. To reduce the risk of burns and other personal injury from escaping gas, vapor and fumes, allow the power tool to cool. If you need to refuel before completing a job, turn off the machine and allow the engine to cool before opening the fuel tank.

Fuel Spilling or "Geysering"

⚠ WARNING

Removing the cap on a pressurized fuel tank can result in gasoline, vapors and fumes being forcefully sprayed out from the fuel tank in all directions. The escaping gasoline, vapors or fumes can cause serious personal injury, including fire and burn injury, or property damage.

FS 311

5

6

FS 311

Sometimes also referred to as "fuel geysering," fuel spraying is an expulsion of fuel, vapors and fumes which can occur in hot conditions, or when the engine is hot, and the tank is opened without allowing the power tool to cool adequately. It is more likely to occur when the fuel tank is half full or more.

Pressure is caused by fuel and heat and can occur even if the engine has not been running. When gasoline in the fuel tank is heated (by ambient temperatures, heat from the engine, or other sources), vapor pressure will increase inside the fuel tank.

Some blends of gasoline, particularly those designed for use in winter, are more volatile and may cause tanks to pressurize more quickly or create greater pressure. At higher altitudes, fuel tank pressurization is more likely.

How to Avoid Fuel Spraying

Removing the fuel cap on a pressurized tank can result in gasoline, vapors and fumes being forcefully sprayed out from the fuel tank in all directions. To reduce the risk of burns, serious injuries or property damage from fuel spraying:

- Follow the fueling instructions in this chapter.
- Always assume your fuel tank is pressurized.
- Allow the power tool to cool before removing the fuel cap.

- In hot environments, cooling will take longer.
- The engine is air cooled. When it is shut off, cooling air is no longer drawn across the cylinder and the engine temperature will rise for several minutes before starting to cool.

After the power tool has cooled appropriately, follow the safety instructions in this chapter for removing the cap.

Never remove the fuel filler cap by turning it directly to the open position. First check for residual pressure in the tank by slowly turning the cap approximately 1/2 turn counterclockwise. The cap should be held in place by the threads while allowing residual vapor/pressure to be relieved. Once the fumes or vapor have been relieved, turn the cap further until it can be removed from the tank opening.

Use only good quality fuel that is appropriate for the season (summer v. winter blends). Some blends of gasoline, particularly winter blends, are more volatile and can contribute to fuel spraying.

Removing the Threaded Fuel Filler Cap

⚠️ WARNING

After allowing the power tool to cool, remove the fuel filler cap slowly and carefully to allow any remaining pressure build-up in the tank to release:

- While maintaining steady, downward pressure, slowly turn the cap approximately 1/2 turn counterclockwise.
- If any significant venting occurs, immediately re-seal the tank by turning the cap clockwise to the closed position. Allow the power tool to cool further before attempting to open the tank.
- Turn the cap to the open position only after the contents of the tank are no longer under pressure.
- Never remove the cap by turning it directly to the open position. First allow the power tool to cool adequately and then release any residual pressure by slowly turning it approximately 1/2 turn counterclockwise.
- Never attempt to remove the cap while the engine is still hot or running.

Installing the Threaded Fuel Filler Cap

⚠️ WARNING

Unit vibrations can cause an improperly tightened fuel filler cap to loosen or come off and spill quantities of fuel. To reduce the risk of fuel spillage and fire, tighten the fuel filler cap by hand with as much force as possible.

Damaged or Broken Cap

If your fuel cap does not tighten properly, it may be damaged or broken. Stop using the power tool and take it to your authorized STIHL dealer for repair.

Vapor Lock

⚠️ WARNING

Vapor lock occurs when fuel in the fuel line or carburetor vaporizes, causing bubbles to block the free flow of liquid fuel into the carburetor. Vapor lock cannot be relieved or affected by opening the fuel tank. Removing the fuel filler cap without first allowing the power tool to cool adequately can result in fuel spraying. Always follow the instructions in this section when removing the fuel cap.

To relieve vapor lock:

- Press the manual fuel pump bulb at least 20 to 30 times – even if the bulb is already filled with fuel – to clear the vapor and send liquid fuel into the carburetor. Then start the power tool. For specific starting instructions, see the appropriate section of your instruction manual.
- If the manual fuel pump bulb will not be filled, place the Choke Knob to the starting throttle position "Z" and pull the starter cord until the engine runs.
- If your power tool will not restart, or if vapor lock occurs again, the power tool is being used in conditions too extreme for the fuel being used. Discontinue use and let the engine cool completely before attempting to start the power tool.

Before Operation

Take off the transport guard and inspect the power tool for proper condition and operation. (See the maintenance chart near the end of the instruction manual.)

⚠️ WARNING

Always check your power tool for proper condition and operation before starting, particularly the throttle trigger, throttle trigger lockout, stop switch, cutting attachment, deflector and harness. The throttle trigger must move freely and always spring back to the idle position. Never attempt to modify the controls or safety devices.

⚠️ WARNING

Check fuel system for leaks, especially the visible parts, e.g., filler cap, hose connections, manual fuel pump (only for power tools equipped with a manual fuel pump). Do not start the engine if there are leaks or damage – risk of fire. Have the power tool repaired by a STIHL servicing dealer before using it.

⚠️ WARNING

Never operate your power tool if it is damaged, improperly adjusted or maintained, or not completely and securely assembled.

⚠️ WARNING

Check that the spark plug boot is securely mounted on the spark plug – a loose boot may cause arcing that could ignite combustible fumes and cause a fire.

⚠️ WARNING

Do not mount any cutting attachment to a unit without proper installation of all required parts. Failure to use the proper parts may cause the blade or head to fly off and seriously injure the operator or bystanders.

⚠️ WARNING

The cutting attachment must be properly tightened and not damaged. Inspect for loose parts (nuts, screws, etc.) and for cracked or damaged heads or cracked, bent, warped or damaged blades.

Replace damaged heads or blades before using the power tool. Always keep blades sharp.

Keep the handles clean and dry at all times; it is particularly important to keep them free of moisture, pitch, oil, fuel mix, grease or resin in order for you to maintain a firm grip and properly control your power tool.

⚠️ WARNING

To reduce the risk of personal injury to the operator from blade or line contact and thrown objects, make sure your unit is equipped with the proper deflector, limit stop and harness for the type of cutting attachment being used (see chart in the chapter on "Approved Combinations of Cutting Attachments, Deflector, Limit Stop and Harness").

As can be seen in that chart, some cutting attachments may require you to change your deflector, limit stop and / or harness.

Keep the deflector (and the attached skirt where appropriate) adjusted properly at all times (see chapters on "Mounting the Deflector" and "Mounting the Cutting Attachment" of your instruction manual).

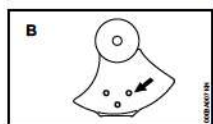
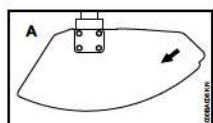

Arrows on the deflector (A) and limit stop (B) (as seen from the underside) show the correct direction of rotation of the cutting attachment. When viewed from above, however, the cutting attachment rotates counterclockwise.

Adjust carrying harness and hand grip to suit your size before starting work. The machine should be properly balanced as specified in your instruction manual for proper control and less fatigue in operation. To be better prepared in case of an emergency, practice releasing the unit from the harness as quickly as possible.

For specific starting instructions, see the appropriate section of your instruction manual.

Starting

Start the engine at least 10 feet (3 m) from the fueling spot, outdoors only.

For specific starting instructions, see the appropriate section of your manual. Place the power tool on a firm ground or other solid surface in an open area. Maintain good balance and secure footing.

⚠️ WARNING

To reduce the risk of injury from blade or line contact, be absolutely sure that the cutting attachment is clear of you and all other obstructions and objects, including the ground, because when the engine starts at starting-throttle, engine speed will be fast enough for the clutch to engage and move the cutting attachment.

Once the engine has started, immediately blip the throttle trigger, which should release the starting throttle and allow the engine to slow down to idle.

With the engine running only at idle, attach the power tool to the spring hook of your harness (see appropriate chapter of this manual).

⚠️ WARNING

Your power tool is a one-person machine. Do not allow other persons in the general work area, even when starting.

⚠️ WARNING

To reduce the risk of injury from loss of control, do not attempt to "drop start" your power tool.

⚠️ WARNING

When you pull the starter grip, do not wrap the starter rope around your hand. Do not let the grip snap back, but guide the starter rope to rewind it properly. Failure to follow this procedure may result in injury to your hand or fingers and may damage the starter mechanism.

Important Adjustments

⚠️ WARNING

To reduce the risk of personal injury from loss of control or contact with the running cutting attachment, do not use your unit with incorrect idle speed. At correct idle speed, the cutting attachment should not move. For directions on how to adjust idle speed, see the appropriate section of your instruction manual.

If you cannot set the correct idle speed, have your STIHL dealer check your power tool and make proper adjustments and repairs.

During Operation

Holding and Controlling the Power Tool

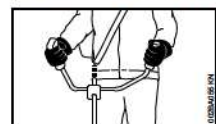

Always hold the unit firmly with both hands on the handles while you are working. Wrap your fingers and thumbs around the handles, keeping the handles cradled between your thumb and forefinger. Keep your hands in this position to have your power tool under control at all times. Make sure your clearing saw handles and grips are in good condition and free of moisture, pitch, oil, fuel mix or grease.

⚠️ WARNING

Never attempt to operate your power tool with one hand. Loss of control of the power tool resulting in serious or fatal injury may result. To reduce the risk of cut injuries, keep hands and feet away from the cutting attachment. Never touch a moving cutting attachment with your hand or any other part of your body.

⚠️ WARNING

Do not overreach. Keep proper footing and balance at all times. Special care must be taken in slippery conditions (wet ground, snow) and in difficult, overgrown terrain. Watch for hidden obstacles such as tree stumps, roots and ditches to avoid stumbling. For better footing, clear away scrub and cuttings. Be extremely cautious when working on slopes or uneven ground.

⚠️ WARNING

To reduce the risk of injury from loss of control, never work on a ladder or on any other insecure support. Never hold the cutting attachment above waist height.

Working Conditions

Operate and start your power tool only outdoors in a well-ventilated area. Operate it under good visibility and daylight conditions only. Work carefully.

WARNING

As soon as the engine is running, this product generates toxic exhaust fumes containing chemicals, such as unburned hydrocarbons (including benzene) and carbon monoxide, that are known to cause respiratory problems, cancer, birth defects, or other reproductive harm. Some of the gases (e.g. carbon monoxide) may be colorless and odorless. To reduce the risk of serious or fatal injury / illness from inhaling toxic fumes, never run the machine indoors or in poorly ventilated locations.

WARNING

If the vegetation being cut or the surrounding ground is coated with a chemical substance (such as an active pesticide or herbicide), read and follow the instructions and warnings that accompanied the substance at issue.

WARNING

Inhalation of certain dusts, especially organic dusts such as mold or pollen, can cause susceptible persons to have an allergic or asthmatic reaction. Substantial or repeated inhalation of dust and other airborne contaminants, in particular those with a smaller particle size, may cause respiratory or other illnesses. Control dust at the source

where possible. Use good work practices, such as operating the unit so that the wind or operating process directs any dust raised by the power tool away from the operator. Follow the recommendations of EPA / OSHA / NIOSH and occupational and trade associations with respect to dust ("particulate matter"). When the inhalation of dust cannot be substantially controlled, i.e., kept at or near the ambient (background) level, the operator and any bystanders should wear a respirator approved by NIOSH / MSHA for the type of dust encountered.

Operating Instructions

WARNING

Do not operate your power tool using the starting throttle lock, as you do not have control of the engine speed.

In the event of an emergency, shut off the engine immediately by pressing the stop switch.

WARNING

The cutting attachment continues to rotate for a short period after the throttle trigger is released (flywheel effect).

WARNING

The rotating cutting attachment may fling foreign objects directly or by ricochet a great distance.

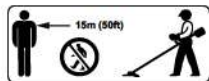

To reduce the risk of eye and other injury always wear proper eye protection (see the chapter on "Proper Clothing") and ensure that bystanders are at least 50 feet (15 m) away. To reduce the risk of damage to property, also maintain this distance from such objects as vehicles or windows. Even maintaining a minimum distance of 15 meters cannot exclude the potential danger. Any coworkers who must be in the restricted area should also wear goggles or protective glasses. Stop the engine immediately if you are approached.

WARNING

Inspect the work area: To reduce the risk of injury, remove stones, pieces of metal and other solid objects which could be thrown 15 meters or more by the cutting attachment or damage the cutting attachment and property (e.g. parked vehicles, windows).

WARNING

This clearing saw is normally to be used at ground level with the cutting attachment parallel to the ground. Use of a clearing saw above ground level or with the cutting attachment perpendicular to the ground may

English

English

increase the risk of injury, since the cutting attachment is more fully exposed and the power tool may be more difficult to control. Never use your clearing saw as a hedge trimmer.

WARNING

During cutting, check the tightness and the condition of the cutting attachment at regular short intervals with the engine and attachment stopped. If the behavior of the attachment changes during use, stop the engine immediately, wait until the cutting attachment stops, and check the nut securing the attachment for tightness and the blade or head for cracks, wear and damage.

WARNING

A loose blade or head may vibrate, crack, break or come off the clearing saw, which may result in serious or fatal injury. Make sure that the cutting attachment is properly tightened. Use the wrench supplied or one of sufficient length to obtain the proper torque. If the blade or head loosens after being properly tightened, stop work immediately. The retaining nut may be worn or damaged and should be replaced. If the blade or head continues to loosen, see your STIHL dealer. Never use a clearing saw with a loose cutting attachment.

WARNING

Replace a cracked, damaged or worn-out head or a cracked, bent, warped, damaged, dull or worn blade immediately, even if damage is limited to

superficial cracks. Such attachments may shatter at high speed and cause serious or fatal injury.

WARNING

When using rigid blades, avoid cutting close to fences, sides of buildings, tree trunks, stones or other such objects that could cause the power tool to kick out or could cause damage to the blade. STIHL recommends use of the nylon line heads for such jobs. In addition, be alert to an increased possibility of ricochets in such situations.

WARNING

If a rotating metal blade strikes a rock or other hard object, sparks may be created, which can ignite flammable materials under certain circumstances. Flammable materials can include dry vegetation and brush, particularly when weather conditions are hot and dry. When there is a risk of fire or wildfire, do not use metal blades around flammable materials or around dry vegetation or brush. Contact your local fire authorities or the U.S. Forestry Service if you have any question about whether vegetation and weather conditions are suitable for the use of a metal blade.

WARNING

If the head, blade or deflector becomes clogged or stuck, always shut off the engine and make sure the cutting attachment has stopped before cleaning. Grass, weeds, etc. should be cleaned off the blade or from around the head at regular intervals.

WARNING

To reduce the risk of unintentional rotation of the cutting attachment and injury, always shut off the engine and remove the spark plug boot before replacing the cutting attachment. To reduce the risk of injury, always shut off the engine before adjusting the length of the nylon line on manually adjustable mowing heads.

WARNING

The gearbox becomes hot during operation. To reduce the risk of burn injury, do not touch the gear housing when it is hot.

WARNING

Never modify your muffler. Any modification could cause an increase in heat radiation, sparks or sound level, thereby increasing the risk of fire, burn injury or hearing loss. You may also permanently damage the engine. Have your muffler serviced and repaired by your STIHL servicing dealer only.

WARNING

The muffler and other parts of the engine (e.g. fins of the cylinder, spark plug) become hot during operation and remain hot for a while after stopping the engine. To reduce risk of burns, do not touch the muffler and other parts while they are hot. Keep the area around the muffler clean. Remove excess substrate and all debris such as pine needles, branches or leaves. Let the engine cool down

FS 311

11

12

FS 311

sitting on concrete, metal, bare ground or solid wood (away from any combustible substances).

WARNING

An improperly mounted or damaged cylinder housing or a damaged/deformed muffler shell may interfere with the cooling process of the muffler. To reduce the risk of fire or burn injury, do not continue work with a damaged or improperly mounted cylinder housing or a damaged/deformed muffler shell.

Your muffler is furnished with a spark arresting screen designed to reduce the risk of fire from the emission of hot particles. Never operate your unit with a missing or damaged spark arresting screen. If your gas/oil mix ratio is correct (i.e., not too rich), this screen will normally stay clean as a result of the heat from the muffler and need no service or maintenance. If you experience loss of performance and you suspect a clogged screen, have your muffler maintained by a STIHL servicing dealer. Some state or federal laws or regulations may require a properly maintained spark arrester for certain uses. See the "Maintenance, Repair and Storing" section of these Safety Precautions. Remember that the risk of a brush or forest fire is greater in hot or dry conditions.

WARNING

Some STIHL power tools are equipped with a catalytic converter, which is designed to reduce the exhaust emissions of the engine by a chemical process in the muffler. Due to this process, the muffler does not cool down as rapidly as conventional mufflers when the engine returns to idle or is shut off. To reduce the risk of fire and burn injuries when using a catalytic converter, always set your power tool down in the upright position and never locate it where the muffler is near dry brush, grass, wood chips or other combustible materials while it is still hot.

USING THE CUTTING ATTACHMENT

For an illustration of the various cutting attachments and instructions on proper mounting see the chapter on "Mounting the Cutting Attachment" in your instruction manual.

WARNING

To reduce the risk of severe or fatal injury from blade contact and / or loss of control, never attempt to use a metal blade on an FS model for which it is not authorized.

Using the Mowing Heads

Do not use with mowing line longer than the intended length. With a properly mounted deflector, the built-in line-limiting blade will automatically adjust the line to its proper length.

Using the unit with an overly long nylon cutting line increases the load on the engine and reduces its operating speed. This causes the clutch to slip continuously and results in overheating and damage to important components (e.g. clutch, polymer housing components). Such damage could, among other things, cause the cutting attachment to rotate at idle.

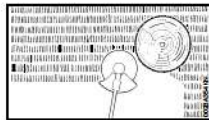

Mowing heads are to be used only on clearing saws equipped with a line-limiting blade in the deflector in order to keep the line at the proper length (see "Main Parts" chapter in your instruction manual).

If the lawn edges are planted with trees or bordered by a fence etc., it is best to use a nylon line head. It achieves a "softer" cut with less risk of damaging tree bark etc. than polymer blades.

However, the polymer-bladed STIHL PolyCut produces a better cut if there are no plants along the edge of the lawn. Sharpening is not necessary, and worn polymer blades are easily replaced.

English

English

WARNING

To reduce the risk of serious injury, never use wire or metal-reinforced line or other material in place of the nylon cutting lines. Pieces of wire could break off and be thrown at high speed toward the operator or bystanders.

STIHL SuperCut mowing head

Fresh line is advanced automatically. Frayed line is replaced by a simple adjustment (see instruction sheet supplied with mowing head).

STIHL AutoCut mowing head

Nylon cutting line advances automatically when tapped against the ground (TapAction).

STIHL TrimCut mowing head

Frayed line is replaced by a simple adjustment (see instruction sheet supplied with mowing head).

STIHL DuroCut mowing head



Uses only nylon lines. Observe wear indicators.

NOTE

There are four wear limit indicators shaped like exclamation marks in the base of the DuroCut. If one of these

built-in indicators becomes visible, do not continue using the DuroCut since it might otherwise be damaged. Replace the worn base plate with a new base plate. It is important to follow the maintenance instructions supplied with the head.

STIHL PolyCut mowing head

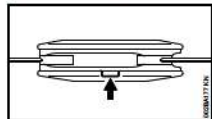

Uses either nylon lines or nonrigid, pivoting polymer blades. Observe wear indicators.

WARNING

Three rectangular wear limit marks are applied to the base (periphery) of the PolyCut. To reduce the risk of serious injury from breakage of the head or blades, the PolyCut must not be used when it has worn as far as one of these marks. It is important to follow the maintenance instructions supplied with the head.

WARNING

If the wear limit marks are ignored, there is a risk of the cutting attachment shattering and flying parts injuring the operator or bystanders. To reduce the risk of accidents from shattered blades, avoid contact with stones, metal and similar solid objects. Check PolyCut

blades for cracks at regular intervals. If a crack is found on one blade, always replace all blades.

Risk of Kickout (Blade Thrust) with all Rigid Cutting Blades

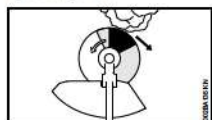

WARNING

Kickout (blade thrust) is the sudden and uncontrolled motion towards the operator's right or rear that can occur when the shaded area (especially the darkly shaded area) of a rotating blade comes in contact with a solid rigid object like a tree, rock, bush or wall. The rapid counterclockwise rotation of the blade may be stopped or slowed, and the cutting attachment may be thrown to the right or to the rear.

This kickout (blade thrust) may cause loss of control of the power tool and may result in serious or fatal injury to the operator or bystanders. To reduce the risk of injury, extreme caution should be used when cutting with the shaded area of any rigid blade.

FS 311

13

14

FS 311

Using the Grass Cutting Blade

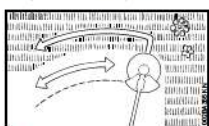

All kinds of grass and weeds can be easily cut with the grass cutting blade. The power tool is swept in an arc similar to a scythe.

WARNING

To reduce the risk of serious or fatal injury from blade breakage, never attempt to use this blade to cut woody materials.

The 4-tooth grass cutting blade is intended to cut grass and weeds. It has 4 cutting knives with cutting edges on both sides, i.e. front and rear. When the cutting edges on one side become dull, the blade can be turned over to utilize the cutting edges on the other side.

The 8-tooth grass cutting blade is recommended for cutting fern or reed. Both types of grass cutting blade have to be resharpened when all cutting edges are dull.

Using the Brush Knife

When fitted to the power tool, the brush knife is suitable for applications ranging from cutting matted grass to clearing weeds, wild growth and scrub.

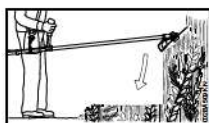

To cut wild growth and scrub, lower the rotating brush knife down onto the growth to achieve a chopping effect – but keep the tool below waist height at all times.

WARNING

Exercise extreme caution when using this method of cutting. The higher the cutting attachment is off the ground, the greater the risk of loss of control and of cuttings being thrown sideways.

Use the power tool like a scythe to cut grass, i.e. sweep it to and fro in an arc.

WARNING

When cutting woody materials, use the left side of the blade to avoid "kickout" (blade thrust) situations.

WARNING

Improper use of a brush knife may cause it to crack, chip or shatter. Thrown blade fragments may seriously or fatally injure the operator or bystanders. To reduce the risk of injury, avoid contact with hard or solid foreign objects such as stones, rocks or pieces of metal.

WARNING

When cutting young saplings or other woody materials up to 2 cm (3/4 in.) in diameter, use the left side of the blade to avoid "kickout" situations (see section on "Risk of kickout (blade thrust)" with all rigid cutting blades). Do not attempt to cut woody material with a larger diameter, since the blade may catch or jerk the power tool forward. This may cause damage to the blade or power tool or loss of control of the power tool, resulting in personal injury. Use a circular saw blade for such work.

WARNING

Inspect the brush knife at regular short intervals for signs of damage. Do not continue working with a damaged brush knife. Resharpen the brush knife regularly (when it has dulled noticeably).

Using the Circular Saw Blade



Circular saw blades are suitable for thinning brush and cutting small trees up to a diameter of 7 cm (2 3/4 in.). Do not attempt to cut trees with larger diameters, since the blade may catch or jerk the clearing saw forward. This may cause damage to the blade or loss of

control of the power tool and result in serious injury. Use a chain saw for such work.

WARNING

To reduce the risk that the blade will crack and / or break, avoid all contact with stones, rocks or the ground. Sharpen blades in a timely manner as specified – dull teeth may cause the blade to crack or shatter.

When a clearing saw with a circular saw blade is used to cut down small trees, STIHL recommends that the standard deflector be removed and replaced by the special limit stop deflector (see chapter on "Mounting the Deflector"). This limit stop helps to keep the unit positioned against the tree during the cutting process. Inexperienced users should place the left side of the stop against the tree trunk before beginning to cut. This will keep the clearing saw against the tree during the cutting operation and will reduce the risk of loss of control and possible kickout (described above and briefly again below).

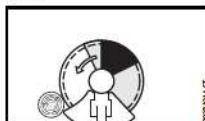

Before starting the cut, accelerate the engine up to full throttle. Perform cut with uniform pressure. STIHL recommends that the circular saw blade

be applied to the right of the tree, using the non-shaded area of the blade, as shown in the illustration above.

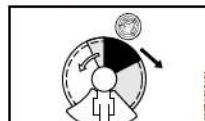

WARNING

The risk of kickout is highest when cutting in the darker shaded area. To reduce the risk of kickout and resulting injury, do not use this area of the circular saw blade for cutting trees or shrubs. Special techniques using the lighter shaded areas of the blade to cut shrubs and trees should only be used by experienced operators with specialized training in the use and control of the clearing saw.

When felling small trees, maintain a distance of at least two tree lengths from the nearest coworker.

WARNING

In order to reduce the risk of injury from thrown objects or operator contact with the blade or head, be sure to remount the standard deflector when no longer using a circular saw blade.

MAINTENANCE, REPAIR AND STORING

Maintenance, replacement, or repair of the emission control devices and systems may be performed by any nonroad engine repair establishment or individual. However, if you make a warranty claim for a component which has not been serviced or maintained properly, STIHL may deny coverage.

WARNING

Use only identical STIHL replacement parts for maintenance and repair. Use of non-STIHL parts may cause serious or fatal injury.

Strictly follow the maintenance and repair instructions in the appropriate sections of your instruction manual.

WARNING

Always stop the engine and make sure that the cutting attachment is stopped before doing any maintenance or repair work or cleaning the power tool. Do not attempt any maintenance or repair work not described in your instruction manual. Have such work performed by your STIHL servicing dealer only.

Wear gloves when handling or performing maintenance on blades.

WARNING

Use the specified spark plug, and make sure it and the ignition lead are always clean and in good condition. Always press the spark plug boot snugly onto the spark plug terminal of the proper size. (Note: If the terminal has a

detachable SAE adapter nut, it must be securely attached.) A loose connection between the spark plug and the ignition wire connector in the boot may create arcing that could ignite combustible fumes and cause a fire.

WARNING

Never test the ignition system with the spark plug boot removed from the spark plug or with a removed spark plug, since uncontained sparking may cause a fire.

WARNING

Do not operate your power tool if the muffler is damaged, missing or modified. An improperly maintained muffler will increase the risk of fire and hearing loss. Your muffler is equipped with a spark-arresting screen to reduce the risk of fire; never operate your power tool if the screen is missing, damaged or clogged. Remember that the risk of a brush or forest fire is greater in hot or dry weather.

In California, it is a violation of § 4442 or § 4443 of the Public Resources Code to use or operate gasoline-powered tools on forest-covered, brush-covered or grass-covered land unless the engine's exhaust system is equipped with a complying spark arrester that is maintained in effective working order. The owner/operator of this product is responsible for properly maintaining the spark arrester. Other states or governmental entities/agencies, such as the U.S. Forest Service, may have similar requirements. Contact your local fire agency or forest service for the laws or regulations relating to fire protection requirements.

WARNING

Never repair damaged cutting attachments by welding, straightening or modifying the shape. This may cause parts of the cutting attachment to come off and result in serious or fatal injuries.

Keep blades sharp. Tighten all nuts, bolts and screws, except the carburetor adjustment screws, after each use.

Do not clean your machine with a pressure washer. The solid jet of water may damage parts of the machine.

Store the power tool in a dry and high or locked location out of reach of children.

Before storing for longer than a few days, always empty the fuel tank. See chapter "Storing the Machine" in the instruction manual.

Approved Combinations of Cutting Attachment, Deflector, Limit Stop and Harness

Cutting Attachment			Deflector, Limit Stop	Harness
1	2	3	13	16
4	5	6	14	17
8	9	10	15	17
11	12			

Approved Combinations

Select correct combination from the table according to the cutting attachment you intend to use.

WARNING

To reduce the risk of injury, only the cutting attachments and deflectors or limit stops shown in each row of the table may be used together. No other combinations are permitted.

Cutting Attachments**Mowing heads**

- 1 STIHL SuperCut 40-2
- 2 STIHL AutoCut 40-2
- 3 STIHL AutoCut 46-2
- 4 STIHL TrimCut 40-2
- 5 STIHL TrimCut 41-2
- 6 STIHL DuroCut 40-4
- 7 STIHL PolyCut 40-3

Metal cutting attachments

- 8 Grass cutting blade 230-4 (230 mm dia.)
- 9 Grass cutting blade 255-8 (255 mm dia.)
- 10 Brush knife 300-3 (300 mm dia.)
- 11 Scratcher tooth circular saw blade 200 (200 mm dia.)
- 12 Chisel tooth circular saw blade 200-22 (4119), chisel tooth circular saw blade 200-22 HP (4000)

WARNING

Non-metal grass cutting blades, brush knives and circular saw blades are not approved.

Deflectors, Limit Stop

- 13 Deflector for mowing heads
- 14 Deflector for grass cutting blades and brush knives
- 15 Limit stop for circular saw blades

Harness

- 16 Full harness must be used
- 17 Full "deluxe" harness must be used

WARNING

Based on the cutting attachment being used:

Choose the proper deflector in order to reduce the risk of serious personal injury from thrown objects and contact with the cutting attachment.

Make sure your unit is equipped with the proper handle and harness in order to reduce the risk of serious personal injury from loss of control and contact with the cutting attachment.

To reduce the risk of serious personal injury from contact with the cutting attachment, use grass cutting metal blades and brush knives on this unit only if equipped with a bike handle or a loop handle with barrier bar. Use circular saw blades on this unit only if equipped with a bike handle.

Do not use rigid polymer blades on this unit.

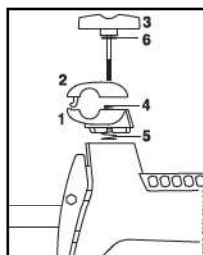
Mounting the Bike Handle**Mounting the Bike Handle**

- Hold the lower clamp (1) and upper clamp (2) firmly together.
- Loosen the clamp screw (3) – the clamp moldings are loose once the clamp screw has been loosened. They are pushed apart by the two springs (4 and 5).
- Pull out the clamp screw – the washer (6) remains on the screw.
- Separate the clamp moldings – the springs (4 and 5) remain in the lower clamp.

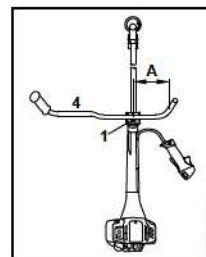

- Place the handlebar (4) in the lower clamp molding (1) so that distance A is no more than 15 cm (6 in).
- Place the upper clamp molding (2) in position and press it down.
- Insert the clamp screw (3).
- Line up the handlebar (4) at a right angle to the drive tube.
- Tighten down the clamp screw (3) firmly.

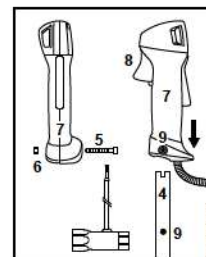

- Take out the screw (5), the nut (6) remains in the control handle (7).
- Push the control handle onto the handlebar (4) until the holes (9) line up – the throttle trigger (8) must point towards the gearbox.
- Insert the screw and tighten it down firmly.
- Go to "Adjusting the Throttle Cable".

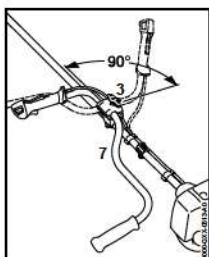
Swinging handlebar into transport position

- Loosen the wing screw (3) and unscrew it until the handlebar (7) can be rotated.
- Rotate the handlebar 90° counterclockwise and then swing the handles down.
- Tighten down the wing screw (3) firmly.

Swinging handlebar into working position

- Reverse the sequence described above to swing the handles up and turn the handlebar clockwise.

Adjusting the Throttle Cable

It may be necessary to correct the adjustment of the throttle cable after assembling the machine or after a prolonged period of operation.

Adjust the throttle cable only when the unit is completely and properly assembled.

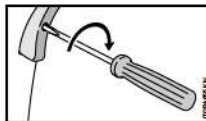

- Set the throttle trigger to the full throttle position.
- Carefully rotate the screw in the throttle trigger in the direction of the arrow until you feel initial resistance. Then rotate it another half turn in the same direction.

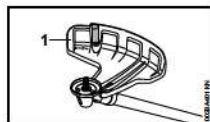
Mounting the Deflector**Use the Right Deflector****WARNING**

Deflector (1) is approved for mowing heads only and must therefore be mounted before fitting a mowing head.

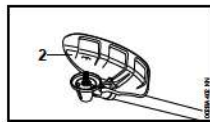
**WARNING**

Deflector (2) is approved for grass cutting blades and brush knives only and must therefore be mounted before fitting a grass cutting blade or brush knife.

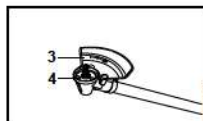
**WARNING**

The limit stop (3) is approved as a deflector for circular saw blades only and must therefore be mounted before fitting a circular saw blade. It is also necessary to change the guard ring (5), see "Mounting the Cutting Attachment" / "Mounting Circular Saw Blades".

Mounting the Deflector

Deflectors (1 to 3) are mounted to the gearbox in the same way.



- Remove dirt from joints on gearbox and deflector – make sure that no dirt gets into the screw holes in the gearbox.
- Place the deflector on the gearbox (5).
- Insert the screws (6) and tighten them down firmly.

Mounting the Cutting Attachment**Placing power tool on the ground**

- Shut off the engine.
- Lay your power tool on its back so that the cutting attachment mounting face is pointing up.

Use the Right Guard Ring

Your power tool comes standard with a guard ring.

The guard ring is also available as a special accessory.

The guard ring must be mounted with particular care. Have this work performed by your servicing dealer. STIHL recommends a STIHL servicing dealer.

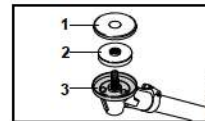
Guard ring for mowing applications

Always fit guard ring (1) when using

- mowing heads
- grass cutting blades
- brush knives
- shredder blades

to ensure optimum protection against grass cuttings.

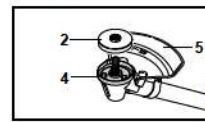
Guard ring for sawing applications

Fit guard ring (4) only when you use circular saw blades.

Mounting the Thrust Plate and Guard Washer

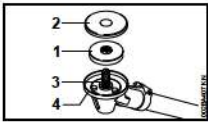

- Fit the thrust plate (1) and guard washer (2) on the shaft (3).

NOTICE

The thrust plate (1) on the gearbox is necessary for mounting all cutting attachments.

NOTICE

The guard washer (2) is required for mounting

- mowing heads
- grass cutting blades
- brush knives
- shredder blades

to the gearbox. The guard washer is not required for mounting circular saw blades.

Checking the Thrust Plate

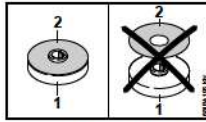

The thrust plate consists of the thrust plate body (1) to which a captive guard washer (2) is fitted.

WARNING

Never use a thrust plate without the guard washer. Always replace a thrust plate if the guard washer is missing.

Cleaning Gearbox Mounting Hardware for Cutting Attachment

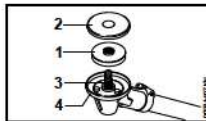

NOTICE

Check inside of guard ring (4) and area around it for dirt at regular intervals, or when you change the cutting attachment, and clean if necessary as follows:

- Pull the guard washer (1) and thrust plate (2) off the shaft.
- Thoroughly clean the guard ring, shaft, thrust plate and guard washer – do not remove the guard ring.

Blocking the Shaft

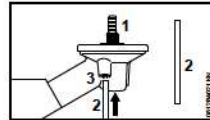

The output shaft (1) must be blocked with the stop pin (2) to mount or remove cutting attachments. The stop pin is included with the machine and is available as a special accessory.

- Insert the stop pin (2) in the bore (3) in the gearbox as far as stop, apply slight pressure.
- Rotate shaft or cutting attachment until the stop pin slips into position and blocks the shaft.

Mounting the Cutting Attachment

WARNING

Use a deflector that matches the cutting attachment – see "Mounting the Deflector".

English

English

Fitting the mowing head with screw mounting

Keep the leaflet and packaging of the metal cutting attachment in a safe place.

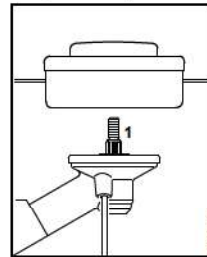

- Fit the thrust plate
- Turn the mowing head anticlockwise on the shaft (1) as far as it will go
- Retain the shaft
- Tighten the mowing head

NOTICE

Remove the tool that was used to block the shaft.

Removing the Mowing Head

- Retain the shaft
- Turn the mowing head clockwise

Removing and Installing Metal Cutting Attachments

Keep the leaflet and packaging of the metal cutting attachment in a safe place.

WARNING

Wear protective gloves to reduce the risk of direct contact with the sharp cutting edges.

Mount only one metal cutting attachment.

Mounting Grass Cutting Blades, Brush Knife

Notice on new machines that come standard with a mowing head only: A "metal mowing attachment mounting kit" is required to mount a grass cutting blade or brush knife. Kits are available from your servicing dealer.

Check direction of rotation of cutting attachment

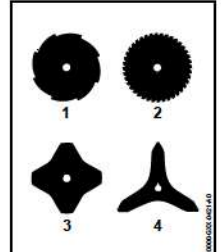

The cutting edges of the cutting attachments 1 and 2 must point clockwise.

Cutting attachments 3 and 4 may be mounted either way round – they must be turned over regularly to help avoid one-sided wear.

- Use guard ring for mowing attachments.

FS 311

23

24

FS 311

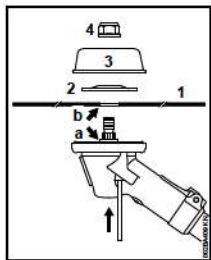

- Place the cutting attachment (1) in position.

WARNING

Collar (a) must locate in the cutting attachment's mounting hole (b).

Securing the cutting attachment

- Fit the thrust washer (2) – convex side must face up.
- Fit the rider plate (3).
- Block the shaft.
- Fit the nut (4) counterclockwise and tighten it down firmly.

WARNING

If the mounting nut has become too loose, fit a new one.

NOTICE

Remove the tool used to block the shaft.

Removing the cutting attachment

- Block the shaft.
- Unscrew the nut clockwise.
- Pull the cutting attachment with its mounting hardware off the gearbox.

Mounting Circular Saw Blades

A limit stop kit, which includes a limit stop and a guard ring for circular saw blades, is available as a special accessory for mounting circular saw blades.

Notice on new machines that come standard with a mowing head only: Further mounting hardware is necessary for a circular saw blade. It is available from your servicing dealer.

Change the guard ring.

Recommendation: The guard ring must be mounted with particular care. Have this work performed by your servicing dealer. STIHL recommends a STIHL servicing dealer.

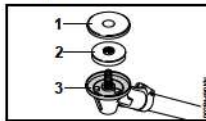

- Remove the guard washer (1) and thrust plate (2).
- Remove the guard ring (3) for mowing attachments.
- Keep the guard washer and guard ring in a safe place for future use.

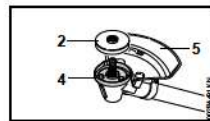

- Fit the guard ring (4) for saw blades.
- Slip the thrust plate (2) over the shaft.
- Fit the limit stop (5) for circular saw blades.

NOTICE

Do not use the guard washer (1) with circular saw blades.

Check direction of rotation of cutting attachment

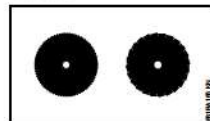

Cutting edges of circular saw blades must point clockwise.

English

English

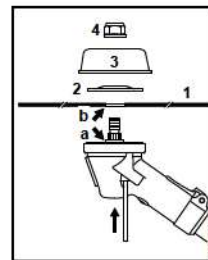

- Place the cutting attachment (1) in position.

WARNING

Collar (a) must locate in the cutting attachment's mounting hole (b).

Securing the cutting attachment

- Fit the thrust washer (2) – convex side must face up.
- Fit the rider plate (3).
- A rider plate (3) for sawing applications is available as a special accessory. It allows the full depth of cut of the saw blade to be used.
- Block the shaft.
- Fit the nut (4) counterclockwise and tighten it down firmly.

WARNING

If the mounting nut has become too loose, fit a new one.

NOTICE

Remove the tool used to block the shaft.

Removing the cutting attachment

- Block the shaft.
- Unscrew the mounting nut clockwise.
- Pull the cutting attachment with its mounting hardware off the gearbox.

NOTICE

Remove the tool used to block the shaft.

Fuel

This engine is certified to operate on unleaded gasoline and the STIHL two-stroke engine oil at a mix ratio of 50:1.

Your engine requires a mixture of high-quality gasoline and two-stroke air cooled engine oil.

Use mid-grade unleaded gasoline with a minimum octane rating of 89 ((R+M)/2) and no more than 10% ethanol content.

Fuel with an octane rating below 89 may increase engine temperatures. This, in turn, increases the risk of piston seizure and damage to the engine.

The chemical composition of the fuel is also important. Some fuel additives not only detrimentally affect elastomers (carburetor diaphragms, oil seals, fuel lines, etc.), but magnesium castings and catalytic converters as well. This could cause running problems or damage the engine. For this reason STIHL recommends that you use only quality unleaded gasoline!

Gasoline with an ethanol content of more than 10% can cause running problems and major damage to engines and should not be used.

For further details, see www.STIHLusa.com/ethanol

The ethanol content in gasoline affects engine speed – it may be necessary to readjust the carburetor if you use fuels with various ethanol contents.

FS 311

25

26

FS 311

WARNING

To reduce the risk of personal injury from loss of control and / or contact with the running cutting tool, do not use your unit with incorrect idle adjustment. At correct idle speed, the cutting tool should not move.

If your power tool's idle speed is incorrectly adjusted, have your authorized STIHL servicing dealer check your machine and make the proper adjustments and repairs.

The idle speed and maximum speed of the engine change if you switch from a fuel with a certain ethanol content to another fuel with a much higher or lower ethanol content.

This problem can be avoided by always using fuel with the same ethanol content.

To ensure the maximum performance of your STIHL engine, use a high quality 2-cycle engine oil, such as STIHL 2-cycle engine oils. STIHL 2-cycle engine oils are specially designed for STIHL engines. To help your engine run cleaner and reduce harmful carbon deposits, STIHL recommends using STIHL HP Ultra 2-cycle engine oil, or use an equivalent high quality 2-cycle engine oil.

To meet the requirements of EPA and CARB we recommend to use STIHL HP Ultra oil or equivalent.

Do not use NMMA or TCW rated (two-stroke water cooled) mix oils or other mix oils that state they are for use in both water cooled and air cooled engines (e.g., outboard motors, snowmobiles, chain saws, mopeds, etc.).

Take care when handling gasoline. Avoid direct contact with the skin and avoid inhaling fuel vapor. When filling at the pump, first remove the container from your vehicle and place the container on the ground before filling. To reduce the risk of sparks from static discharge and resulting fire and/or explosion, do not fill fuel containers that are sitting in or on a vehicle or trailer.

The container should be kept tightly closed in order to limit the amount of moisture that gets into the mixture.

The machine's fuel tank should be cleaned as necessary.

STIHL MotoMix

STIHL recommends the use of STIHL MotoMix. STIHL MotoMix has a high octane rating and ensures that you always use the right gasoline/oil mix ratio.

STIHL MotoMix uses STIHL HP Ultra two-stroke engine oil suited for high performance engines.

For further details, see www.STIHLUSA.com/ethanol

Fuel mix ages

If not using STIHL MotoMix, only mix sufficient fuel for a few days of work, not to exceed 30 days of storage. Store in approved fuel-containers only. When mixing, pour oil into the container first, and then add gasoline. Close the container and shake it vigorously by hand to ensure proper mix of oil and gasoline.

Gasoline	Oil (STIHL 50:1 or equivalent high-quality oils)
Liters	Liters (ml)
1	0.02 (20)
5	0.10 (100)
10	0.20 (200)
20	0.40 (400)

US gal.	US fl.oz.
1	2.6
2 1/2	6.4
5	12.8

Dispose of empty mixing-oil containers only at authorized disposal locations.

Fueling**WARNING**

Removing the cap on a pressurized fuel tank can result in gasoline, vapors and fumes being forcefully sprayed out from the tank in all directions. The escaping gasoline, vapors or fumes, sometimes referred to as fuel spraying or "geysering," can cause serious personal injury, including fire and burn injury, or property damage.

Fuel spraying can occur when the engine is hot and the tank is opened while under pressure. It can occur in hot environments even if the engine has not been running. Spraying is more likely to occur when the fuel tank is half full or more.

Avoid Injuries from Fuel Spraying.

Always follow the fueling instructions in this manual:

- Treat every fuel tank as if it is pressurized, particularly if it is half full or more.
- Always allow the power tool to cool adequately before attempting to open the fuel tank or refueling; this will take longer in hot conditions.

- Never remove the cap by turning it directly to the open position. Turn it first approximately 1/2 of a turn counter-clockwise to relieve any residual pressure.
- Never open the fuel tank while the engine is still hot or running.
- Never open the fuel tank or re-fuel the power tool near any sparks, flames or other ignition sources.
- Pick the right fuel: use only good quality (89 octane or higher), fresh fuel blended for the season.
- Vapor lock: do not remove the fuel cap in an effort to relieve vapor lock. Removing the cap has no effect on vapor lock.
- Be aware that fuel spraying is more likely at higher altitudes.

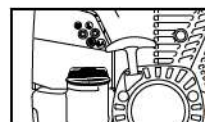
**Preparations**

- Before fueling, clean the filler cap and the area around it to ensure that no dirt falls into the tank.
- Position the machine so that the filler cap is facing up.

WARNING

In order to reduce the risk of fire and other personal injury from escaping gas vapor and fumes, remove the fuel filler cap slowly and carefully so as to allow any pressure build-up in the tank to release slowly.

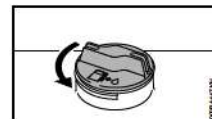
Opening**WARNING**

After allowing the power tool to cool, remove the fuel filler cap slowly and carefully to allow any remaining pressure build-up in the tank to release:

- While maintaining steady, downward pressure, slowly turn the cap approximately a 1/2 turn counter-clockwise.
- If any significant venting occurs, immediately re-seal the tank by turning the cap clockwise to the closed position. Allow the power tool to cool further before attempting to open the tank.
- Turn the cap to the open position only after the contents of the tank are no longer under pressure.
- Remove the fuel filler cap.

WARNING

Never remove the cap by turning it directly to the open position. First allow the power tool to cool adequately and then release any residual pressure by slowly turning the cap approximately 1/2 turn counter-clockwise. Never attempt to remove the cap while the engine is still hot or running.

Refueling

Take care not to spill fuel while fueling and do not overfill the tank – leave approximately 1/2" (13 mm) air space.

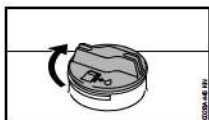
Closing**WARNING**

An improperly tightened fuel filler cap can loosen or come off and spill quantities of fuel. To reduce the risk of fuel spillage and fire from an improperly installed fuel cap, tighten the fuel filler cap by hand with as much force as possible:

- If your fuel cap still does not tighten properly, it may be damaged or broken. Stop using the power tool and take it to your authorized STIHL dealer for repair or replacement.

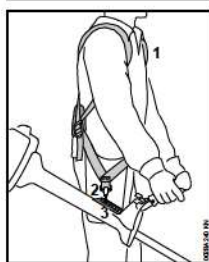
Fitting the Full Harness

- Put on the full harness (1).
- Adjust the length of the strap so that the spring hook (2) is about a hand's width below your right hip. Over-long ends of straps may be shortened after completing the adjustment.
- Attach the spring hook to the machine's perforated strip (3).

Find the right attachment point for the cutting attachment you are using – see "Balancing the Brushcutter".

Balancing the Machine

The unit is balanced differently, depending on the cutting attachment used.

- With the unit suspended from the harness, see how it is balanced and change attachment point as necessary:

Mowing attachments

Mowing heads, grass cutting blades and brush knives should just touch the ground.

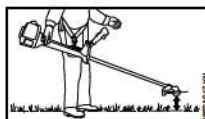
Circular saw blades

Circular saw blades should "hover" about 8 in. (20 cm) above the ground.

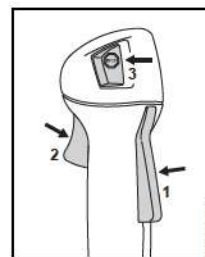
Starting / Stopping the Engine**Controls**

- 1 Throttle trigger lockout
- 2 Throttle trigger
- 3 Stop switch with Run and Stop positions. Depress the stop switch (I) to switch off the ignition – see "Function of stop switch and ignition system".

Function of stop switch and ignition system

The ignition is switched off and the engine stopped when the stop switch is pressed. The stop switch returns automatically to the Run position when it is released. The ignition is switched on again after the engine stops – the engine is then ready to start.

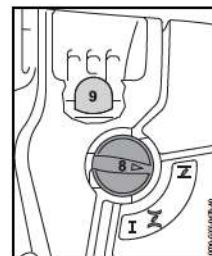
Starting the Engine

- Press the manual fuel pump bulb (9) at least five times – even if the bulb is already filled with fuel.
- Press in the choke knob (8) and turn it to the position that suits the engine temperature:

I if the engine is cold
Z for warm start – also use this position if the engine has been running but is still cold.

The choke knob must engage in position.

Cranking

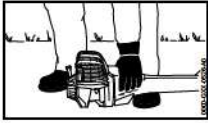

- Place the unit on the ground: It must rest securely on the engine support and the deflector.
- If fitted: Remove the transport guard from the cutting attachment.

To reduce the risk of accidents, check that the cutting attachment is not touching the ground of any other obstacles.

- Make sure you have a firm footing, either standing, stooping or kneeling.
- Hold the unit firmly on the ground with your left hand and press down – do not touch the throttle trigger or lockout lever – your thumb should be under the fan housing.

NOTICE

Do not stand or kneel on the drive tube.



- Hold the starter grip with your right hand.
- Pull the starter grip slowly until you feel it engage and then give it a brisk strong pull.

NOTICE

Do not pull out the starter rope all the way – it might otherwise break.

- Do not let the starter grip snap back. Guide it slowly back into the housing so that the starter rope can rewind properly.
- Continue cranking until the engine runs.

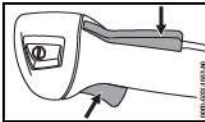
As soon as the engine runs

- Press down the throttle trigger lockout and open the throttle – the choke knob moves to the run position I. After a cold start, warm up the engine by opening the throttle several times.

WARNING

There is a risk of injury if the cutting attachment runs when the engine is idling. Adjust the carburetor so that the cutting attachment does not run when the engine is idling – see "Adjusting the Carburetor".

Your machine is now ready for operation.

Stopping the Engine

- Depress the momentary contact stop switch – the engine stops – release the stop switch – it springs back to the run position.

Other Hints on Starting**Engine stalls in cold start position I or under acceleration.**

- Move the choke knob to Z and continue cranking until the engine runs.

Engine does not start in warm start position Z.

- Move the choke knob to I and continue cranking until the engine runs.

If the engine does not start

- Check that all settings are correct.
- Check that there is fuel in the tank and refuel if necessary.
- Check that the spark plug boot is properly connected.
- Repeat the starting procedure.

Engine is flooded

- Move the choke knob to I and continue cranking until the engine runs.

Fuel tank run until completely dry

- After refueling, press the manual fuel pump bulb at least five times – even if the bulb is already filled with fuel.
- Set the choke knob to suit the engine temperature.
- Now start the engine.

Transporting the Unit**Using Transport Guard**

The type of transport guard depends on the metal cutting attachment supplied with the machine. Transport guards are available as special accessories.

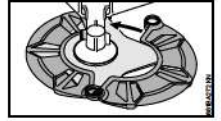
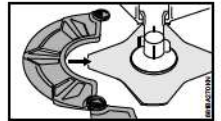
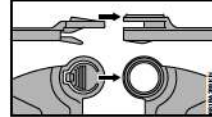
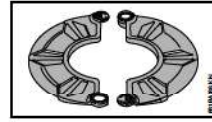
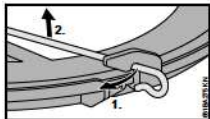
230 mm Grass Cutting Blades**Circular Saw Blades**

- Disconnect wire rod from the transport guard.

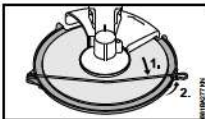

- Swing wire rod into position.
- Hook wire rod to the transport guard.

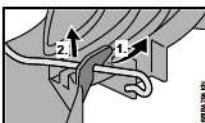
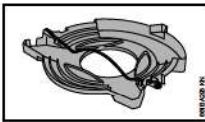
Universal Transport Guard

- Swing wire rod outwards.
- Fit transport guard on saw blade from below, making sure the limit stop is properly seated in the recess.

- Disconnect wire rod from the transport guard and swing it outwards.

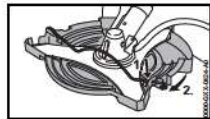

- Fit the transport guard on the cutting attachment from below.
- Attach wire rod to the hook on the transport guard.

Operating Instructions**During break-in period**

A factory-new machine should not be run at high revs (full throttle off load) for the first three tank fillings. This avoids unnecessary high loads during the break-in period. As all moving parts have to bed in during the break-in period, the frictional resistances in the engine are greater during this period. The engine develops its maximum power after about 5 to 15 tank fillings.

During Operation

After a long period of full throttle operation, allow the engine to run for a short while at idle speed so that engine heat can be dissipated by the flow of cooling air. This protects engine-mounted components (ignition, carburetor) from thermal overload.

After Finishing Work

Storing for a short period: Wait for the engine to cool down. Empty the fuel tank and keep the machine in a dry place, well away from sources of ignition, until you need it again. For longer out-of-service periods – see "Storing the Machine".

Replacing the Air Filter

Filters have an average life of more than a year. Do not remove the filter cover or replace the air filter as long as there is no noticeable loss of power.

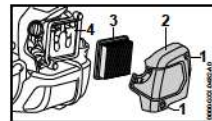
If there is a noticeable loss of engine power

- Turn the choke knob to I.
- Loosen the screws (1).
- Remove the filter cover (2).
- Clean away loose dirt from around the filter.
- Remove the filter element (3).
- Replace dirty or damaged filter element (3).
- Replace any damaged parts.

Installing the Filter Element

- Install the filter element (3) in the filter housing and fit the cover.
- Insert the screws (1) and tighten them down firmly.

Engine Management

Exhaust emissions are controlled by the design of the engine and components (e.g. carburation, ignition, timing and valve or port timing).

Adjusting the Carburetor

The carburetor has been set at the factory to provide an optimum fuel-air mixture under most operating conditions.

Adjusting Idle Speed



Engine stops while idling

- Warm up the engine for about 3 minutes.
- Turn the idle speed screw (LA) slowly clockwise until the engine runs smoothly – the cutting attachment must not run.

Cutting attachment runs when engine is idling

- Turn the idle speed screw (LA) slowly counterclockwise until the cutting attachment stops running and then turn the screw about another 1/2 to 3/4 turn in the same direction.

WARNING

If the cutting attachment continues to run when the engine is idling, have your machine checked and repaired by your servicing dealer.

Spark Arresting Screen in Muffler

WARNING

To reduce the risk of fire caused by hot particles escaping from the machine, never operate the machine without a spark arresting screen, or with the spark arresting screen damaged. Do not modify the muffler or spark arresting screen.

NOTICE

According to the law or regulations in some countries or federal states, certain operations may only be carried out if a properly serviced spark arresting screen is provided.

- If the engine is down on power, check the spark arresting screen in the muffler.
- Wait for the muffler to cool down

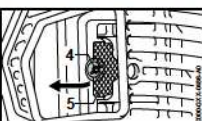

- Undo screw (4)
- Lift the spark arresting screen (5) and pull it out.
- Clean the spark arresting screen (5). If the screen is damaged or heavily carbonized, install a new one.

- Refit the spark arresting screen (5)
- Insert and tighten screw (4)

Spark Plug

If there is a loss of engine power, the machine is difficult to start or runs poorly at idle, first check the spark plug.

Install a new spark plug after approximately 100 operating hours or earlier if the electrodes are eroded/corroded.

The wrong fuel mix (too much engine oil in the gasoline), a dirty air filter and unfavorable running conditions (mostly at part throttle etc.) affect the condition of the spark plug. These factors cause deposits to form on the insulator nose, which may degrade performance.

Removing the Spark Plug



- Remove the cover (1).
- Pull off the spark plug boot (2).
- Unscrew the spark plug (3).

Checking the spark plug

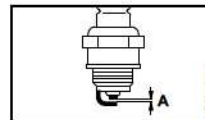

- Clean the spark plug if it is dirty
- Check the electrode gap (A) and readjust if necessary – see "Specifications"
- Use only resistor type spark plugs of the approved range. See the chapter "Specifications" in this instruction manual

Correct the problems that have caused fouling of the spark plug:

- too much oil in fuel mix;
- dirty air filter; or
- unfavorable running conditions, e.g. operating at part throttle.

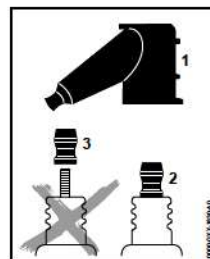

WARNING

To reduce the risk of fire and burn injury, use only spark plugs authorized by STIHL. Always press the spark plug boot (1) firmly and securely onto the spark plug terminal (2).

Do not use a spark plug with a detachable SAE adapter terminal (3). Arcing may occur that could ignite combustible fumes and cause a fire. This can result in serious injuries or damage to property.

- Only use resistor type spark plugs with solid, non-threaded terminals

Installing the Spark Plug

- Screw the spark plug (3) into the cylinder.
- Tighten down the spark plug (3) with the combination wrench.

- Press the boot (2) firmly onto the spark plug.
- Fit the cover (1) and screw it down firmly.

Storing the Machine

For periods of about 3 months or longer

- Drain and clean the fuel tank in a well ventilated area.
- Dispose of fuel properly in accordance with local environmental requirements.
- Run the engine until the carburetor is dry – this helps prevent the carburetor diaphragms sticking together.
- Remove, clean and inspect the cutting attachment. Coat metal cutting attachments with corrosion inhibitor.
- Thoroughly clean the machine – pay special attention to the cylinder fins and air filter.
- Store the machine in a dry and secure location – out of the reach of children and other unauthorized persons.

Sharpening Metal Cutting Blades

- Use a sharpening file (see "Special Accessories") to sharpen dull cutting attachments. In case of more serious wear or nicks: Resharpener with a grinder or have the work done by a dealer – STIHL recommends a STIHL servicing dealer.
- Sharpen frequently, take away as little metal as possible – two or three strokes of the file are usually enough.

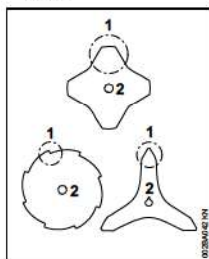

- Resharpener the teeth (1) uniformly – do not alter the contour of the parent blade (2) in any way.

See cutting attachment packaging for additional sharpening instructions. Keep the packaging for future reference.

Balancing

- After resharpening about 5 times, check the cutting attachment for out-of-balance on a STIHL balancer – see "Special Accessories" – or have it checked by a dealer and re-balanced as necessary – STIHL recommends a STIHL servicing dealer.

Maintaining the Mowing Head

Placing power tool on the ground



- Shut off the engine.
- Lay your power tool on its back so that the cutting attachment mounting face is pointing up.

Replacing Nylon Line

Always check the mowing head for signs of wear before replacing the nylon line.

WARNING

If there are signs of serious wear, replace the complete mowing head.

The nylon mowing line is referred to as "nylon line" or "line" in the following.

The mowing head is supplied with illustrated instructions for replacing the nylon line. Keep the instructions for the mowing head in a safe place.

- If necessary, remove the mowing head.

Adjusting Nylon Line

STIHL SuperCut

Fresh line is advanced automatically if the remaining line is at least 6 cm (2 1/2 in) long. The blade on the deflector trims overlong lines to the correct length.

STIHL AutoCut

- With the engine running, hold the rotating mowing head above the grass surface.
- Tap it on the ground once – fresh line is advanced and the blade on the deflector trims it to the right length.

Fresh line is advanced every time the mowing head is tapped on the ground. For this reason observe the mowing head's cutting performance during operation. If the mowing head is tapped on the ground too often, the line limiting blade will unnecessarily cut off unused lengths of nylon line.

Line feed operates only if both lines are still at least 2.5 cm (1 in) long.

STIHL TrimCut

WARNING

To reduce the risk of injury, always shut off the engine before adjusting the nylon line by hand.

- Pull the spool up – rotate it about 1/6 turn counterclockwise until it engages – and allow it to spring back.
- Pull ends of the lines outward.

Repeat the above procedure as necessary until both lines reach the limiter blade on the deflector.
Rotating the spool from one stop to the next advances about 4 cm (1 1/2 in) of fresh line.

Replacing Nylon Line

STIHL PolyCut

Precut lengths of nylon line can be fitted to the PolyCut in place of the cutting blades.

STIHL DuroCut, STIHL PolyCut

WARNING

To reduce the risk of injury, always shut off the engine before refilling the mowing head.

- Fit precut lengths of nylon line in the mowing head as described in the instructions supplied.

Replacing Cutting Blades

STIHL PolyCut

Always check the mowing head for signs of wear before installing new cutting blades.

WARNING

If there are signs of serious wear, replace the complete mowing head. The thermoplastic cutting blades are referred to as "blades" in the following.

The mowing head is supplied with illustrated instructions for replacing the blades. Keep the instructions for the mowing head in a safe place.

WARNING

To reduce the risk of injury, always shut off the engine before installing the blades.

- Remove the mowing head.
- Replace blades as shown in the illustrated instructions.
- Mount the mowing head on the machine.

Maintenance and Care

The following intervals apply to normal operating conditions only. If your daily working time is longer or operating conditions are difficult (very dusty work area, etc.), shorten the specified intervals accordingly.

		before starting work	after starting work or daily	after each refueling stop	weekly	monthly	every 12 months	if problem	if damaged	as required
Complete machine	Visual inspection (condition, leaks)	X								
	Clean		X							
	Replace any damaged parts	X							X	
Control handle	Check operation	X		X						
	Visual inspection					X		X		
Air filter	Replace ¹⁾							X		X
	Check	X								
Manual fuel pump (if fitted)	Have repaired by servicing dealer ¹⁾									X
	Have checked by servicing dealer ¹⁾							X		
Pickup body (filter) in fuel tank	Have replaced by servicing dealer ¹⁾						X		X	X
	Clean							X		X
Fuel tank	Check life adjustment – the cutting attachment must not rotate	X		X						
	Adjust idle speed									X
	Adjust electrode gap							X		
Spark plug	Replace after every 100 operating hours									
	Visual inspection		X							
Cooling inlets	Clean									X
	Have cleaned by servicing dealer ¹⁾						X			
Valve clearance	if power is low or cranking effort very high, have valve clearance checked and, if necessary, adjusted by servicing dealer ¹⁾							X		X
	Check		X					X		
Spark arresting screen in muffler	Clean or replace								X	X

		before starting work	after starting work or daily	after each refueling stop	weekly	monthly	every 12 months	if problem	if damaged	as required
All accessible screws and nuts (not adjusting screws)	Tighten									X
Anti-vibration elements (rubber buffers, springs)	Check	X						X		X
	Have replaced by servicing dealer ¹⁾								X	
Cutting attachment	Visual inspection	X		X					X	
	Replace									
Metal Cutting Attachment	Check tightness	X		X						X
	Sharpen	X								
Gearbox lubrication	Check				X					
	Replenish									X
Safety labels	Replace								X	

¹⁾ STIHL recommends an authorized STIHL servicing dealer.
²⁾ Only if there is a noticeable loss of engine power.

Main Parts

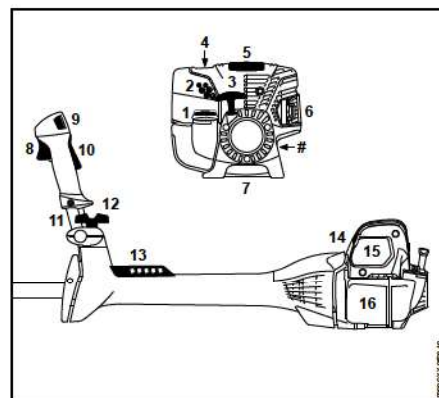

- 1 Fuel Filler Cap
- 2 Carburetor Adjusting Screws
- 3 Starter Grip
- 4 Manual Fuel Pump
- 5 Cover
- 6 Muffler with Spark Arresting Screen
- 7 Machine Support
- 8 Throttle Trigger
- 9 Stop Switch
- 10 Throttle Trigger Lockout
- 11 Bike Handle
- 12 Clamp Screw
- 13 Carrying Strip
- 14 Choke Knob
- 15 Air Filter Cover
- 16 Fuel Tank
- # Serial Number