

MLC OPERATOR'S MANUAL



Part No. M00968 A
Printed in the USA

MLC CONSTRUCTION PRO SERIES MATERIAL LIFT

It is the responsibility of the user to read, understand and obey all safety rules before attempting to operate this equipment. This includes all rules and instructions set forth by the manufacturer, as well as any local laws and regulations governing the safe use of this equipment.

It is strongly recommended that only trained and authorized personnel attempt to operate this material lift.

This manual shall be considered a permanent and necessary component of the material lift and shall be kept with the equipment at all times.

LiftSmart is dedicated to the continuous improvement of this and all LiftSmart products. Therefore, technical information contained in this manual is subject to change without notice. Direct any questions regarding errors or discrepancies in this manual to LiftSmart.

Contents

Safety	1
Introduction to the MLC Material Lift	5
Before Operation	13
Operation	17

CONTACT US:

LiftSmart
1345 Specialty Drive, Ste. B
Vista, CA 92081 ☎

P.O. Box 4186
Oceanside, CA 92052-4186

Phone/Fax: 800.717.3079
www.liftsmart.net

Patents Pending.

Copyright © 2011 LiftSmart. All Rights Reserved.

1 SAFETY

Failure to follow all safety rules in this manual and attached to the material lift may result in serious injury or death.

Proper training is strongly recommended before attempting to operate any mechanical device.

Prior to operation:

- Read, understand and obey all safety rules and instructions in this manual and attached to the material lift
- Obtain, read and obey all applicable government regulations
- Become familiar with the proper operation of the material lift
- Inexperienced users should receive instruction before attempting to operate the material lift

BEFORE OPERATION

Follow these safety rules before operating the material lift:

ALWAYS position the material lift on a firm, level surface.

ALWAYS inspect the work area for potential hazards such as overhead obstructions, unstable or slippery surfaces, drop-offs, holes, debris or moving vehicles.



ALWAYS inspect the equipment before operating the material lift. Check for damaged or worn parts. **NEVER** operate a material lift if any damage to the equipment is observed or suspected. **ALWAYS** tag a damaged material lift and remove it from service until repairs are completed according to manufacturer's specifications.

ALWAYS inspect the winch and cable before operating the material lift. Check for wear, frays, kinks and damage to the cable. Verify that the cable is wrapped around the winch drum at least four times when the carriage is lowered. **NEVER** operate a material lift if any damage to the winch or cable is observed or suspected.

NEVER repair the material lift in any way other than according to manufacturer's specifications.

NEVER deface, modify or obscure any decals or markings on the material lift.

NEVER modify the material lift in any way that would affect its original design or operation.

NEVER operate the material lift in any way for which it is not intended.

DURING OPERATION

Follow these safety rules while operating the material lift:

NEVER operate the material lift near power lines. **ALWAYS** ensure that no part of the material lift can accidentally reach into an unsafe area.

⚠ DANGER

The material lift is **NOT** insulated for use near electrical power lines and **DOES NOT** provide protection from contact with or proximity to any electrical current. Maintain safe distances at all times (minimum 3.05 meters; see chart below). Allow for mast movement or electrical line sway due to environmental conditions. **ALWAYS** assume every power line is live.

Voltage Range (Phase to Phase)	Minimum Safe Approach Distance	
	Feet	Meters
0 to 300V	Avoid Contact	
Over 300V to 50KV	10	3.05
Over 50KV to 200KV	15	4.60
Over 200KV to 350KV	20	6.10
Over 350KV to 500KV	25	7.62
Over 500KV to 750KV	35	10.67
Over 750KV to 1000KV	45	13.72

ALWAYS keep away from a material lift that is exposed to energized power lines. If the material lift contacts energized power lines, **NEVER** touch or operate the machine until power lines are shut off.

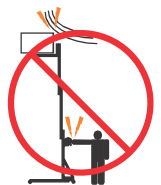

NEVER use the material lift to raise or lower persons.

NEVER stand or climb on the material lift.

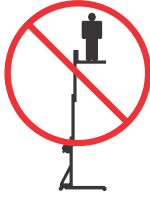

NEVER operate the material lift on a moving or mobile surface, such as a truck bed.



NEVER operate the material lift unless the legs and stabilizers are fully lowered and locked and all casters are in contact with the ground.

NEVER unlock or raise the legs or stabilizers while the material lift is loaded or raised.

ALWAYS keep hands and fingers away from potential pinch and shear points, such as folding legs and stabilizers, mast sections, and as indicated by decals attached to the material lift.

NEVER operate the equipment unless the material lift is located on a firm, level surface.

NEVER use blocks to level the material lift.

ALWAYS center the load on the load lifting attachment and secure the load before operating the material lift.

NEVER stand under the material lift when the load is raised. **NEVER** lower the material lift unless the area below is clear of personnel and obstructions.



NEVER exceed the rated load capacity of the material lift.

NEVER move a material lift with a raised load.

NEVER touch or grab the cable.

NEVER operate the material lift when exposed to high winds, thunderstorms or other weather conditions that could compromise the safety of the operator.



NEVER apply an additional side load or horizontal force to a material lift that is loaded or raised. **NEVER** place ladders or scaffold against the material lift.

NEVER use the material lift as a ground for welding.

NEVER leave the material lift unattended while a load is raised.

THIS PAGE INTENTIONALLY LEFT BLANK ▶

2 INTRODUCTION

MLC Construction Pro Series material lifts are designed to position heavy loads overhead at heights of up to 24 ft 4 in (7.4 m).

Prior to operation:

- Become familiar with the major components of the material lift
- Become familiar with the specifications of the material lift, including maximum height and load capacities
- Verify that all decals are legible and correctly attached to the material lift

COMPONENTS

Become familiar with the major components of the material lift. Familiarity with the components identified on the diagrams below is necessary to ensure safe and proper operation of the material lift.

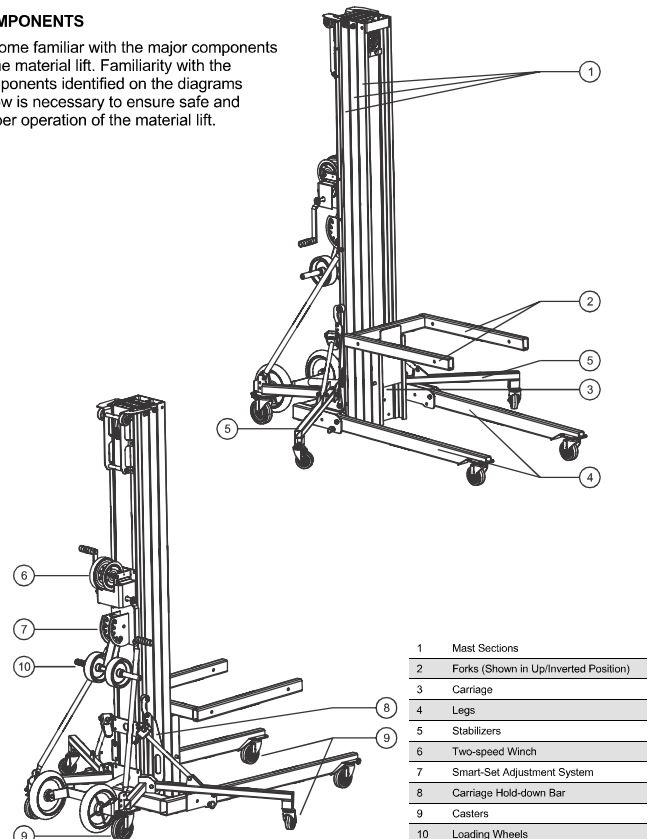

SPECIFICATIONS

LiftSmart is dedicated to the continuous improvement of this and all LiftSmart products. Specifications are subject to change without notice.

	MLC-12	MLC-18	MLC-24
Lift Height			
Standard forks - up	13 ft 3 in 4 m	18 ft 6 in 5.6 m	24 ft 4 in 7.4 m
Standard forks - down	11 ft 6 in 3.5 m	16 ft 10 in 5.1 m	22 ft 7 in 6.9 m
Adjustable forks - up	13 ft 3 in 4 m	18 ft 6 in 5.6 m	24 ft 4 in 7.4 m
Adjustable forks - down	11 ft 6 in 3.5 m	16 ft 10 in 5.1 m	22 ft 7 in 6.9 m
Boom	12 ft 6 in 3.8 m	17 ft 10 in 5.4 m	23 ft 7 in 7.2 m
Height - stowed	7 ft 3 in 2.2 m		
Length - stowed	2 ft 10 in 85 cm		
Length - operating	5 ft 2 in 1.6 m	6 ft 1 in 1.9 m	6 ft 9 in 2.1 m
Width - stowed	30.5 in 77 cm		
Width - stabilizers deployed	5 ft 4 in 1.6 m		
Stabilizers	Optional	Standard	
Forks - Length	30 in 76 cm		
Forks - Width - outside	23 in 58 cm		
Maximum load capacity			
14 in (36 cm) load center	750 lb 340 kg	700 lb 318 kg	650 lb 295 kg
24 in (61 cm) load center	450 lb 205 kg	440 lb 200 kg	430 lb 195 kg
42 in (107 cm) load center	200 lb 91 kg	185 lb 84 kg	175 lb 80 kg
Ground clearance	2.5 in 6 cm		
Load height - minimum	6 in 15 cm		
Weight	234 lb 106 kg	320 lb 145 kg	365 lb 166 kg
Winch cranks/distance			
High speed	4 cranks/ft 13.1 cranks/m		
Low speed	15 cranks/ft 49.2 cranks/m		

3 BEFORE OPERATION

A visual inspection of the machine is required to determine if any part of the material lift is worn or damaged. Testing the material lift before placing a load on the equipment will determine if there are any malfunctions.

If any worn or damaged components are observed or suspected, or if the equipment malfunctions, remove the material lift from service immediately. Repairs to the material lift should only be performed by authorized personnel according to the manufacturer's specifications.

An inspection of the work area will determine if the area is safe for operation of the material lift.

Prior to operation:

- Visually inspect the material lift for worn or damaged components
- Set up and test the material lift to determine if there are any malfunctions
- Inspect the work area

VISUAL INSPECTION

Before operating the material lift:

- Inspect the wheels and casters for excessive wear or damage
- Inspect the material lift for loose, damaged or missing fasteners
- Inspect the base, legs, stabilizers, mast sections, pulleys and forks for damage and improperly installed or missing components
- Inspect the cable for wear, frays, kinks or damage
- Verify that the cable is wrapped around the winch drum at least four times when the carriage is lowered
- Inspect the entire material lift for dents, damage, excessive rust or corrosion and cracks in welds or on structurally critical components, such as mast sections
- Verify that all decals are legible and correctly attached to the material lift

⚠ WARNING

If any worn or damaged components are observed or suspected, remove the material lift from service immediately. Repairs to the material lift should only be performed by authorized personnel according to the manufacturer's specifications.

SET UP

- To set up the machine, select an area that is firm, level and clear of debris and overhead obstructions.

Follow these steps to set up the machine:**If the material lift is equipped with stabilizers:**

- Push down on the stabilizer lock plates to release the stabilizers
- Lower the stabilizers until the casters are in contact with the ground
- Verify that the lock plates are engaged and the stabilizers are locked in the down position



- Remove the leg retainer pin
- Lower the leg to the down position
- Insert the leg retainer pin through the leg and the base

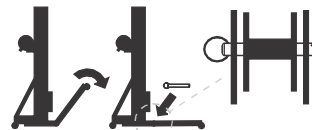

- Repeat the above steps to lower and secure the other leg
- Place the desired load lifting attachment (standard forks, adjustable forks, boom) inside the carriage

- Insert the fork retainer pin through the load lifting attachment and the carriage

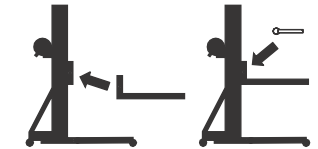

- Engage the locking toggle on the fork retainer pin
- Rotate the carriage hold-down bar up and away from the carriage

If the material lift is equipped with adjustable forks:

- Pull up on the snap pins
- Adjust the forks to the desired width
- Verify that the snap pins are properly inserted

To install fork extensions:

- Slide the extension tube onto the fork
- Adjust the extension tubes to the desired position
- Insert the retaining pins through the extension tube and the fork

If the material lift is equipped with a load platform:

- Place the load platform on the forks

FUNCTION TEST

After the material lift is set up, perform the following test to verify that the equipment is not malfunctioning:

- Shift the winch to the slow speed
- Firmly grasp both winch handles
- Rotate the winch handles toward the mast to raise the carriage to its full height

The winch should operate smoothly, without hesitation or binding, and the motion should raise the carriage to the top of the first mast section followed in order by each consecutive mast section.

- Rotate the winch handles away from the mast to completely lower the carriage
- Rotate the winch handles one quarter-turn toward the mast - as if raising the carriage - to set the brake

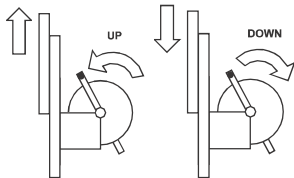

The winch should operate smoothly, without hesitation or binding.

⚠ WARNING

If the equipment malfunctions, remove the material lift from service immediately. Repairs to the material lift should only be performed by authorized personnel according to the manufacturer's specifications.

SET UP

- To set up the machine, select an area that is firm, level and clear of debris and overhead obstructions.

Follow these steps to set up the machine:

If the material lift is equipped with stabilizers:

- Push down on the stabilizer lock plates to release the stabilizers
- Lower the stabilizers until the casters are in contact with the ground
- Verify that the lock plates are engaged and the stabilizers are locked in the down position



- Remove the leg retainer pin
- Lower the leg to the down position
- Insert the leg retainer pin through the leg and the base

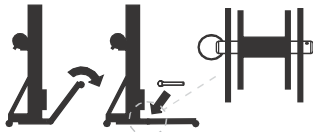

- Repeat the above steps to lower and secure the other leg
- Place the desired load lifting attachment (standard forks, adjustable forks, boom) inside the carriage

WORK AREA INSPECTION

NEVER set up the material lift where any of the following hazards exist:

- Drop-offs
- Holes
- Debris
- Uneven or unstable surfaces
- Surfaces that will not support the forces imposed by the material lift, its operation and its load.
- Slippery surfaces
- Slopes
- Overhead obstructions
- Power lines or other electrical conductors
- High winds or inclement weather
- Moving vehicles

ALWAYS position the material lift on a firm, level surface.

4 OPERATION

The following section provides instructions for the safe and proper operation of the material lift. It is the responsibility of the operator to follow these instructions. Failure to follow these instructions, as well as all safety rules in this manual and attached to the material lift may result in serious injury or death.

During operation:

- Follow all of the safety rules provided in previous sections of this manual
- Follow all instructions provided in this section

SET UP

- To set up the machine, select an area that is firm, level and clear of debris and overhead obstructions.

Follow these steps to set up the machine:

If the material lift is equipped with stabilizers:

- Push down on the stabilizer lock plates to release the stabilizers
- Lower the stabilizers until the casters are in contact with the ground
- Verify that the lock plates are engaged and the stabilizers are locked in the down position



- Remove the leg retainer pin
- Lower the leg to the down position
- Insert the leg retainer pin through the leg and the base

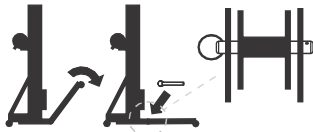

- Repeat the above steps to lower and secure the other leg
- Place the desired load lifting attachment (standard forks, adjustable forks, boom) inside the carriage

- Insert the fork retainer pin through the load lifting attachment and the carriage

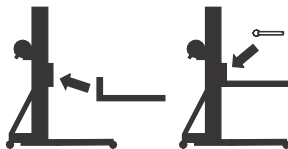

- Engage the locking toggle on the fork retainer pin
- Rotate the carriage hold-down bar up and away from the carriage

If the material lift is equipped with adjustable forks:

- Pull up on the snap pins
- Adjust the forks to the desired width
- Verify that the snap pins are properly inserted

To install fork extensions:

- Slide the extension tube onto the fork
- Adjust the extension tubes to the desired position
- Insert the retaining pins through the extension tube and the fork

If the material lift is equipped with a load platform:

- Place the load platform on the forks

POSITIONING THE LOAD

Determine the following before placing a load on the material lift:

- Weight of the load
- Location of the load center
- Distance between the load center and the side of the load that will be closest to the carriage

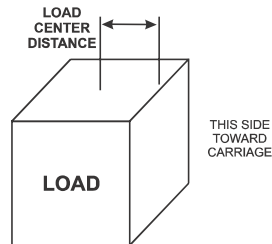

NOTE: Load center refers to the center of gravity of the load and may not be its physical center. The heaviest side of an uneven load should always be positioned closest to the carriage on the material lift.

Refer to the chart below to determine if the material lift can lift the desired weight.

MODEL	Load Center		
	14 in 36 cm	24 in 61 cm	42 in 107 cm
MLC-12	750 lb 340 kg	450 lb 205 kg	200 lb 91 kg
MLC-18	700 lb 318 kg	440 lb 200 kg	185 lb 84 kg
MLC-24	650 lb 295 kg	430 lb 195 kg	175 lb 80 kg

⚠ WARNING

Raising a load that exceeds the rated lift capacity of the material lift creates a tip-over hazard, which may result in serious injury or death.

- Place the load on the load lifting attachment

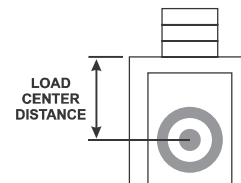

- The load should be as close to the carriage as possible, and the load center should be centered between the forks

⚠ WARNING

Raising a load that is not properly centered on the material lift creates a tip-over hazard, which may result in serious injury or death.

- Secure the load to the load lifting attachment

⚠ WARNING

Raising a load that is not securely fastened to the load lifting attachment creates a tip-over hazard, which may result in serious injury or death.

TWO-SPEED SHIFT

- ❑ To change the winch speed, push the winch handles sideways in the direction of the desired speed

← SLOW • SPEED • FAST →

- ❑ Push the winch handles to the left to shift the winch to the slow speed
- ❑ Push the winch handles to the right to shift the winch to the fast speed
- ❑ Turn the winch handles toward the mast until the winch locks

RAISING AND LOWERING THE LOAD

- ❑ Set up the material lift and position the load according to the procedures on the previous pages
- ❑ Verify that the load is secured to the load lifting attachment
- ❑ Shift the winch to the desired speed
- ❑ Firmly grasp both winch handles
- ❑ Rotate the winch handles toward the mast to raise the load
- ❑ Rotate the winch handles away from the mast to lower the load

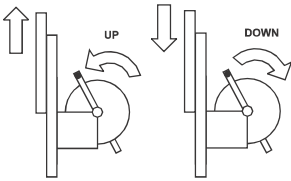

- ❑ After lowering the load to the desired position, rotate the winch handles one quarter-turn toward the mast - as if raising the carriage - to set the brake

AFTER USE

Reverse the set up procedure to prepare the material lift for storage.

Store the material lift on a firm, level surface that is protected from the weather, dirt and other hazards that could reduce the lifespan of the equipment.

TRANSPORT**To transport the material lift:**

- ❑ Remove the fork retaining pin to remove the load lifting attachment from the carriage
- ❑ Turn the winch away from the mast until the carriage is fully lowered

If the material lift is equipped with stabilizers:

- ❑ Push down on the stabilizer lock plates to release the stabilizers
- ❑ Raise the stabilizers to the stowed position
- ❑ Verify that the lock plates are engaged and the stabilizers are locked in the stowed position
- ❑ Rotate the carriage hold-down bar down
- ❑ Raise the carriage until it contacts the carriage hold-down bar

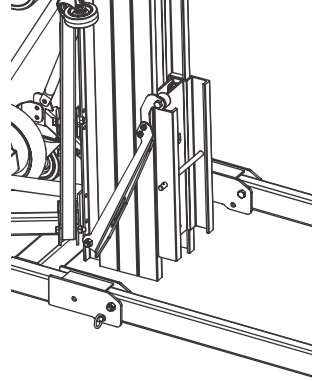

- ❑ Adjust the loading wheel to the height of the truck or trailer bed using the Smart-Set adjustment system; no pin is needed
 - ❑ Lock the rear base casters
 - ❑ Place the material lift against the transport vehicle, with the loading wheels facing the truck or trailer bed
 - ❑ Tilt the material lift towards the transport vehicle until the loading wheels touch the truck or trailer bed
- 
- ❑ Lift the material lift at the base and push it forward to roll it onto the truck or trailer bed
 - ❑ Secure the material lift by placing at least one chain or strap over the mast

CAUTION

Placing the chain or strap over the legs may damage the material lift. Always place the chain or strap over the mast only.

NOTE: Transport of the material lift does not require the legs to be placed in the stowed position. To raise the legs, remove the leg retainer pin and swing the legs into the stowed position. Insert the leg retainer pin.

Reverse the loading instructions to unload the material lift.