

IMPORTANT: Read Before Using
IMPORTANT : Lire avant usage
IMPORTANTE: Leer antes de usar

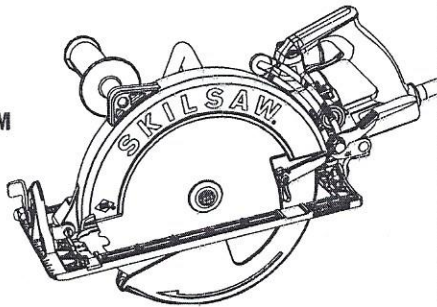

Operating/Safety Instructions
Consignes d'utilisation/de sécurité
Instrucciones de funcionamiento y seguridad

SPT70WM



Call Toll Free for
Consumer Information
& Service Locations

Pour obtenir des informations
et les adresses de nos centres
de service après-vente,
appelez ce numéro gratuit

Lláme gratis para
obtener información
para el consumidor y
ubicaciones de servicio

1-877-SKIL999 (1-877-754-5999) www.skilsaw.com

For English Version
See page 2

Version française
Voir page 19

Versión en español
Ver la página 36

Disconnect the plug from the power source and/or the battery pack from the power tool before making any adjustments, changing accessories, or storing power tools. Such preventive safety measures reduce the risk of starting the power tool accidentally.

Store idle power tools out of the reach of children and do not allow persons unfamiliar with the power tool or these instructions to operate the power tool. Power tools are dangerous in the hands of untrained users.

Maintain power tools. Check for misalignment or binding of moving parts, breakage of parts and any other condition that may affect the power tool's operation. If damaged, have the power tool repaired before use. Many accidents are caused by poorly maintained power tools.

Keep cutting tools sharp and clean. Properly maintained cutting tools with sharp cutting edges are less likely to bind and are easier to control.

Use the power tool, accessories and tool bits etc. in accordance with these instructions, taking into account the working conditions and the work to be performed. Use of the power tool for operations different from those intended could result in a hazardous situation.

Service

Have your power tool serviced by a qualified repair person using only identical replacement parts. This will ensure that the safety of the power tool is maintained.

Safety Rules for Circular Saws

WARNING Read all safety warnings and all instructions.

Cutting procedures

DANGER Keep hands away from cutting area and the blade. Keep your second hand on auxiliary handle, or motor housing. If both hands are holding the saw, they cannot be cut by the blade.

Do not reach underneath the workpiece. The guard cannot protect you from the blade below the workpiece.

Adjust the cutting depth to the thickness of the workpiece. Less than a full tooth of the blade teeth should be visible below the workpiece.

Never hold piece being cut in your hands or across your leg. Secure the workpiece to a stable platform. It is important to support the work properly to minimize body exposure, blade binding, or loss of control.

Hold the power tool by insulated gripping surfaces only, when performing an operation where the cutting tool may contact hidden wiring or its own cord. Contact with a "live" wire will also make exposed metal parts of the tool "live" and could give the operator an electric shock.

When ripping, always use a rip fence or straight edge guide. This improves the

accuracy of cut and reduces the chance of blade binding.

Always use blades with correct size and shape (diamond versus round) of arbor holes. Blades that do not match the mounting hardware of the saw will run eccentrically, causing loss of control.

Never use damaged or incorrect blade washers or bolt. The blade washers and bolt were specially designed for your saw, for optimum performance and safety of operation.

Inspect the condition and quality of the wood and remove all nails from lumber before cutting. Wet lumber, green lumber or pressure treated lumber require special attention during cutting operation to prevent kickback.

Hold the saw firmly to prevent loss of control. Figures in this manual illustrate typical hand support of the saw.

Depending upon use, the switch may not last the life of the saw. If the switch should fail in the "OFF" position, the saw may not start. If it should fail while the saw is running, the saw may not shut off. If either occurs, unplug the saw immediately and do not use until repaired.

General Power Tool Safety Warnings

WARNING Read all safety warnings and all instructions. Failure to follow the warnings and instructions may result in electric shock, fire and/or serious injury.

SAVE ALL WARNINGS AND INSTRUCTIONS FOR FUTURE REFERENCE

The term "power tool" in the warnings refers to your mains-operated (corded) power tool or battery-operated (cordless) power tool.

Work area safety
Keep work area clean and well lit. Cluttered or dark areas invite accidents.

Do not operate power tools in explosive atmospheres, such as in the presence of flammable liquids, gases or dust. Power tools create sparks which may ignite the dust or fumes.

Keep children and bystanders away while operating a power tool. Distractions can cause you to lose control.

Electrical safety
Power tool plugs must match the outlet. Never modify the plug in any way. Do not use any adapter plugs with earthed (grounded) power tools. Unmodified plugs and matching outlets will reduce risk of electric shock.

Avoid body contact with earthed or grounded surfaces such as pipes, radiators, ranges and refrigerators. There is an increased risk of electric shock if your body is earthed or grounded.

Do not expose power tools to rain or wet conditions. Water entering a power tool will increase the risk of electric shock.

Do not abuse the cord. Never use the cord for carrying, pulling or unplugging the power tool. Keep cord away from heat, oil, sharp edges or moving parts. Damaged or entangled cords increase the risk of electric shock.

When operating a power tool outdoors, use an extension cord suitable for outdoor use. Use of a cord suitable for outdoor use reduces the risk of electric shock.

If operating a power tool in a damp location is unavoidable, use a Ground Fault Circuit Interrupter (GFCI) protected supply. Use of an GFCI reduces the risk of electric shock.

Personal safety
Stay alert, watch what you are doing and use common sense when operating a

power tool. Do not use a power tool while you are tired or under the influence of drugs, alcohol or medication. A moment of inattention while operating power tools may result in serious personal injury.

Use personal protective equipment. Always wear eye protection. Protective equipment such as dust mask, non-skid safety shoes, hard hat, or hearing protection used for appropriate conditions will reduce personal injuries.

Prevent unintentional starting. Ensure the switch is in the off-position before connecting to power source and / or battery pack, picking up or carrying the tool. Carrying power tools with your finger on the switch or energizing power tools that have the switch on invites accidents.

Remove any adjusting key or wrench before turning the power tool on. A wrench or a key left attached to a rotating part of the power tool may result in personal injury.

Do not overreach. Keep proper footing and balance at all times. This enables better control of the power tool in unexpected situations.

Dress properly. Do not wear loose clothing or jewelry. Keep your hair, clothing and gloves away from moving parts. Loose clothes, jewelry or long hair can be caught in moving parts.

If devices are provided for the connection of dust extraction and collection facilities, ensure these are connected and properly used. Use of dust collection can reduce dust-related hazards.

Power tool use and care

Do not force the power tool. Use the correct power tool for your application. The correct power tool will do the job better and safer at the rate for which it was designed.

Do not use the power tool if the switch does not turn it on and off. Any power tool that cannot be controlled with the switch is dangerous and must be repaired.

This circular saw should not be mounted to a table and converted to a table saw. Circular saws are not designed or intended to be used as table saws.

This tool is not designed for use with metal or masonry cut-off wheels.

Do not use abrasive wheels with circular saws. Abrasive dust may cause lower guard to fail.

Kickback causes and related warnings

Kickback is a sudden reaction to a pinched, bound or misaligned saw blade, causing an uncontrolled saw to lift up and out of the workpiece toward the operator.

When the blade is pinched or bound tightly by the kerf closing down, the blade stalls and the motor reaction drives the unit rapidly back toward the operator.

If the blade becomes twisted or misaligned in the cut, the teeth at the back edge of the blade can dig into the top surface of the wood causing the blade to climb out of the kerf and jump back toward the operator.

Kickback is the result of tool misuse and/or incorrect operating procedures or conditions and can be avoided by taking proper precautions as given below.

Maintain a firm grip with both hands on the saw and position your arms to resist kickback forces. Position your body to either side of the blade, but not in line with the blade. Kickback could cause the saw to jump backwards, but kickback forces can be controlled by the operator, if proper precautions are taken.

When blade is binding, or when interrupting a cut for any reason, release the trigger and hold the saw motionless in the material until the blade comes to a complete stop. Never attempt to remove the saw from the work or pull the saw backward while the blade is in motion or kickback may occur. Investigate and take corrective action to eliminate the cause of blade binding.

When restarting a saw in the workpiece, center the saw blade in the kerf and check that saw teeth are not engaged into the material. If saw blade is binding, it may walk up or kickback from the workpiece as the saw is restarted.

Support large panels to minimize the risk of blade pinching and kickback. Large panels tend to sag under their own weight. Supports must be placed under the panel on both sides, near the line of cut and near the edge of the panel.

Do not use dull or damaged blades. Unsharpened or improperly set blades produce narrow kerf causing excessive friction, blade binding and kickback.

Blade depth and bevel adjusting locking levers must be tight and secure before making cut. If blade adjustment shifts while cutting, it may cause binding and kickback.

Use extra caution when sawing into existing walls or other blind areas. The protruding blade may cut objects that can cause kickback.

The blade washers and the bolt on your saw have been designed to work as a clutch to reduce the intensity of a kickback. Understand the operation and settings of the VARI-TORQUE CLUTCH. The proper setting of the clutch, combined with firm handling of the saw will allow you to control kickback.

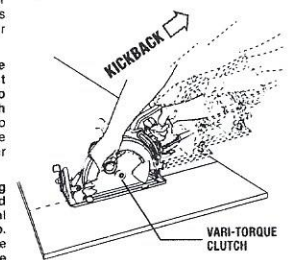

Never place your hand behind the saw blade. Kickback could cause the saw to jump backwards over your hand.

Do not use the saw with an excessive depth of cut setting. Too much blade exposure increases the likelihood of the blade twisting in the kerf and increases the surface area of the blade available for pinching that leads to kickback.

This circular saw should not be mounted to a table and converted to a table saw. Circular saws are not designed or intended to be used as table saws.

This tool is not designed for use with metal or masonry cut-off wheels.

Do not use abrasive wheels with circular saws. Abrasive dust may cause lower guard to fail.

Kickback causes and related warnings

Kickback is a sudden reaction to a pinched, bound or misaligned saw blade, causing an uncontrolled saw to lift up and out of the workpiece toward the operator.

When the blade is pinched or bound tightly by the kerf closing down, the blade stalls and the motor reaction drives the unit rapidly back toward the operator.

If the blade becomes twisted or misaligned in the cut, the teeth at the back edge of the blade can dig into the top surface of the wood causing the blade to climb out of the kerf and jump back toward the operator.

Kickback is the result of tool misuse and/or incorrect operating procedures or conditions and can be avoided by taking proper precautions as given below.

Maintain a firm grip with both hands on the saw and position your arms to resist kickback forces. Position your body to either side of the blade, but not in line with the blade. Kickback could cause the saw to jump backwards, but kickback forces can be controlled by the operator, if proper precautions are taken.

When blade is binding, or when interrupting a cut for any reason, release the trigger and hold the saw motionless in the material until the blade comes to a complete stop. Never attempt to remove the saw from the work or pull the saw backward while the blade is in motion or kickback may occur. Investigate and take corrective action to eliminate the cause of blade binding.

When restarting a saw in the workpiece, center the saw blade in the kerf and check that saw teeth are not engaged into the material. If saw blade is binding, it may walk up or kickback from the workpiece as the saw is restarted.

Support large panels to minimize the risk of blade pinching and kickback. Large panels tend to sag under their own weight. Supports must be placed under the panel on both sides, near the line of cut and near the edge of the panel.

Do not use dull or damaged blades. Unsharpened or improperly set blades produce narrow kerf causing excessive friction, blade binding and kickback.

Blade depth and bevel adjusting locking levers must be tight and secure before making cut. If blade adjustment shifts while cutting, it may cause binding and kickback.

Use extra caution when sawing into existing walls or other blind areas. The protruding blade may cut objects that can cause kickback.

The blade washers and the bolt on your saw have been designed to work as a clutch to reduce the intensity of a kickback. Understand the operation and settings of the VARI-TORQUE CLUTCH. The proper setting of the clutch, combined with firm handling of the saw will allow you to control kickback.

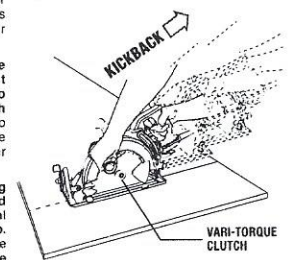

Never place your hand behind the saw blade. Kickback could cause the saw to jump backwards over your hand.

Do not use the saw with an excessive depth of cut setting. Too much blade exposure increases the likelihood of the blade twisting in the kerf and increases the surface area of the blade available for pinching that leads to kickback.

Lower guard function

Check lower guard for proper closing before each use. Do not operate saw if lower guard does not move freely and close instantly. Never clamp or tie the lower guard into the open position. If saw is accidentally dropped, lower guard may be bent. Raise the lower guard only with the lower guard lift lever and make sure it moves freely and does not touch the blade or any other part, in all angles and depths of cut.

Check the operation of the lower guard spring. If the guard and the spring are not operating properly, they must be serviced before use. Lower guard may operate sluggishly due to damaged parts, gummy deposits, or a buildup of debris.

Lower guard should be retracted manually only for special cuts such as "Plunge Cuts" and "Compound Cuts". Raise lower guard by Lower Guard Lift lever and as soon

as blade enters the material, the lower guard must be released. For all other sawing, the lower guard should operate automatically.

Always observe that the lower guard is covering the blade before placing saw down on bench or floor. An unprotected, coasting blade will cause the saw to walk backwards, cutting whatever is in its path. Be aware of the time it takes for the blade to stop after switch is released.

Do not run the tool while carrying it at your side. Lower guard may be opened by a contact with your clothing. Accidental contact with the spinning saw blade could result in serious personal injury.

Periodically remove the blade, clean the upper, lower guards and the hub area with kerosene and wipe it dry, or blow it clean with compressed air. Preventive maintenance and properly operating guard will reduce the probability of an accident.

Additional Safety Warnings

GFCI and personal protection devices like electrician's rubber gloves and footwear will further enhance your personal safety.

Do not use AC only rated tools with a DC power supply. While the tool may appear to work, the electrical components of the AC rated tool are likely to fail and create a hazard to the operator.

Keep handles dry, clean and free from oil and grease. Slippery hands cannot safely control the power tool.

Use clamps or other practical way to secure and support the workpiece to a stable platform. Holding the work by hand or against your body is unstable and may lead to loss of control.

Develop a periodic maintenance schedule for your tool. When cleaning a tool be careful not to disassemble any portion of the tool since internal wires may be misplaced or pinched or safety guard return springs may be improperly mounted. Certain cleaning agents such as gasoline,

carbon tetrachloride, ammonia, etc. may damage plastic parts.

Risk of injury to user. The power cord must only be serviced by a Skil Factory Service Center or Authorized Skil Service Station.

WARNING Some dust created by power sanding, sawing, grinding, drilling, and other construction activities contains chemicals known to cause cancer, birth defects or other reproductive harm. Some examples of these chemicals are:

- Lead from lead-based paints,
- Crystalline silica from bricks and cement and other masonry products, and
- Arsenic and chromium from chemically-treated lumber.

Your risk from these exposures varies, depending on how often you do this type of work. To reduce your exposure to these chemicals: work in a well ventilated area, and work with approved safety equipment, such as those dust masks that are specially designed to filter out microscopic particles.

Symbols

IMPORTANT: Some of the following symbols may be used on your tool. Please study them and learn their meaning. Proper interpretation of these symbols will allow you to operate the tool better and safer.

| Symbol | Name | Designation/Explanation |
|--------------------------|---|---|
| V | Volts | Voltage (potential) |
| A | Amperes | Current |
| Hz | Hertz | Frequency (cycles per second) |
| W | Watt | Power |
| kg | Kilograms | Weight |
| min | Minutes | Time |
| s | Seconds | Time |
| Ø | Diameter | Size of drill bits, grinding wheels, etc. |
| n ₀ | No load speed | Rotational speed, at no load |
| n | Rated speed | Maximum attainable speed |
| .../min | Revolutions or reciprocation per minute | Revolutions, strokes, surface speed, orbits etc. per minute |
| 0 | Off position | Zero speed, zero torque... |
| 1, 2, 3, ... I, II, III, | Selector settings | Speed, torque or position settings. Higher number means greater speed |
| ↻ | Infinitely variable selector with off | Speed is increasing from 0 setting |
| → | Arrow | Action in the direction of arrow |
| ~ | Alternating current | Type or a characteristic of current |
| — | Direct current | Type or a characteristic of current |
| ↔ | Alternating or direct current | Type or a characteristic of current |
| □ | Class II construction | Designates Double Insulated Construction tools. |
| ⊕ | Earthing terminal | Grounding terminal |
| ⚠ | Warning symbol | Alerts user to warning messages |
| ♻️ | Li-ion RBRC seal | Designates Li-ion battery recycling program |
| ♻️ | Ni-Cad RBRC seal | Designates Ni-Cad battery recycling program |
| 📖 | Read manual symbol | Alerts user to read manual |
| 👁️ | Wear eye protection symbol | Alerts user to wear eye protection |

Symbols (continued)

IMPORTANT: Some of the following symbols may be used on your tool. Please study them and learn their meaning. Proper interpretation of these symbols will allow you to operate the tool better and safer.



This symbol designates that this tool is listed by Underwriters Laboratories.



This symbol designates that this component is recognized by Underwriters Laboratories.



This symbol designates that this tool is listed by Underwriters Laboratories, to United States and Canadian Standards.



This symbol designates that this tool is listed by the Canadian Standards Association.



This symbol designates that this tool is listed by the Canadian Standards Association, to United States and Canadian Standards.



This symbol designates that this tool is listed by the Intertek Testing Services, to United States and Canadian Standards.



This symbol designates that this tool complies to NOM Mexican Standards.

Functional Description and Specifications

WARNING Disconnect the plug from the power source before making any assembly, adjustments or changing accessories. Such preventive safety measures reduce the risk of starting the tool accidentally.

SPT70WM Circular Saw

FIG. 1

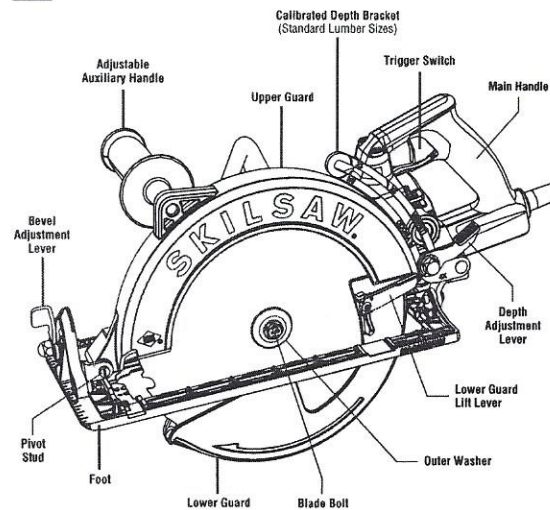

Functional Description and Specifications

WARNING Disconnect the plug from the power source before making any assembly, adjustments or changing accessories. Such preventive safety measures reduce the risk of starting the tool accidentally.

SPT70WM Circular Saw

FIG. 2

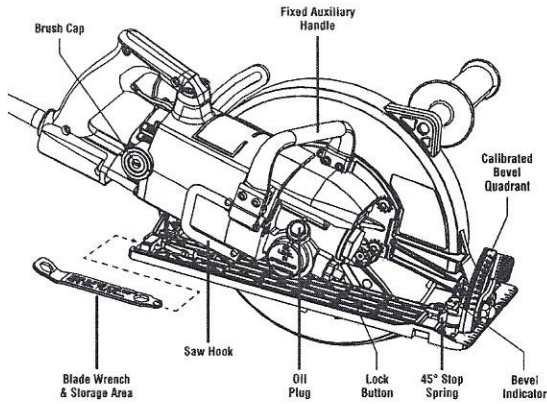

Maximum Capacities

| | | |
|---------------------------|-------|-------------------|
| Blade | | 10-1/4" |
| Blade arbor hole | | Diamond |
| Depth of cut at 90° | | 3-11/16" (93.6mm) |
| Depth of cut at 45° Bevel | | 2-3/4" (69.8mm) |
| Depth of cut at 51° Bevel | | 2-1/2" (63.5mm) |

NOTE: For tool specifications refer to the nameplate on your tool.

Assembly

ATTACHING THE BLADE
WARNING Disconnect the plug from the power source before making any assembly, adjustments or changing accessories. Such preventive safety measures reduce the risk of starting the tool accidentally.

1. Press the lock button (Fig. 2) and turn wrench until lock button engages. Saw shaft is now locked. Continue to depress button, turn wrench clockwise and remove BLADE BOLT and OUTER WASHER (Fig. 3).
2. Make sure the saw teeth and arrow on the blade point in the same direction as the arrow on the lower guard.
3. Retract the lower guard all the way up into the upper guard. While retracting the lower guard, check operation and condition of the LOWER GUARD SPRING.
4. Slide blade through slot in the foot and mount it against the INNER WASHER on the shaft. Be sure the large diameter of the INNER and OUTER washers lay flush against the blade.

5. Reinstall OUTER WASHER. First tighten BLADE BOLT finger tight, then TIGHTEN BLADE BOLT 1/8 TURN (45°) WITH THE WRENCH PROVIDED.

Do not use wrenches with longer handles, since it may lead to over tightening of the blade bolt.

VARI-TORQUE CLUTCH

This clutching action is provided by the friction of the OUTER WASHER against the blade and permits the blade shaft to turn when the blade encounters excessive resistance. When the BLADE BOLT is properly tightened (as described in No. 5 of Attaching The Blade), the blade will slip when it encounters excessive resistance, thus reducing saw's tendency to KICKBACK.

One setting may not be sufficient for cutting all materials. If excessive blade slippage occurs, tighten the blade bolt a fraction of a turn more (less than 1/8 turn). OVERTIGHTENING THE BLADE BOLT NULLIFIES THE EFFECTIVENESS OF THE CLUTCH.

FIG. 3

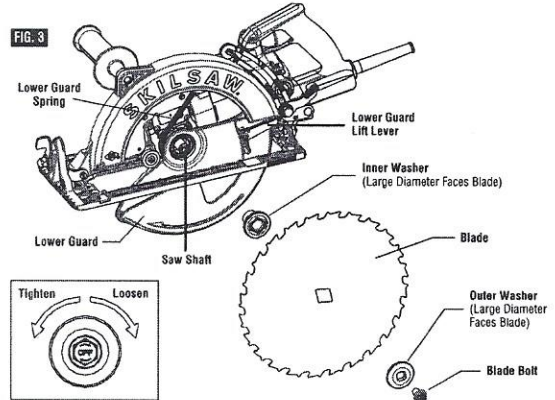

MOUNTING ADJUSTABLE AUXILIARY HANDLE

Disconnect plug from power source. Place the adjustable auxiliary handle onto the threaded hole on the upper guard, facing either right or left preference (Fig. 4). Screw clockwise until handle is tightly in place.

FIG. 4

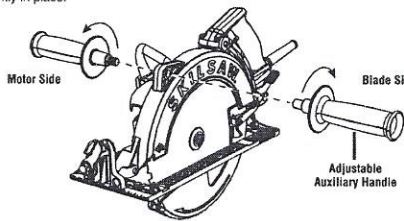

Operating Instructions

DEPTH ADJUSTMENT

Disconnect plug from power source. Loosen the depth adjustment lever located between the guard and handle of saw. Hold the foot down with one hand and raise or lower saw by the handle. Align the bottom contour of depth adjustment lever with the desired depth of cut mark on calibrated depth bracket and tighten lever. Check desired depth (Fig. 1).

Not more than one tooth length of the blade should extend below the material to be cut, for minimum splintering (Fig. 5).

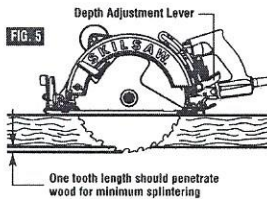

90° CUTTING ANGLE CHECK

Disconnect plug from power source. Set foot to maximum depth of cut setting. Loosen bevel adjustment lever, set the bevel indicator to 0° on quadrant, retighten lever and check for 90° angle between the blade and bottom plane of foot with a square.

Make adjustments by turning the small alignment screw from bottom side of foot, if necessary (Fig. 6).

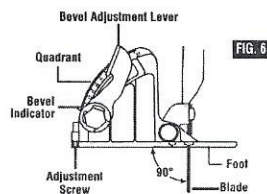

BEVEL ADJUSTMENT

Disconnect plug from power source. The foot can be adjusted up to 45° by loosening the bevel adjustment lever at the front of the saw. Align to desired angle on calibrated quadrant and then tighten bevel adjustment lever (Fig. 7).

For bevel adjustments above 45° loosen bevel adjustment lever, depress 45° stop spring (Fig. 8), align foot to desired angle mark over 45° on quadrant and tighten lever.

For bevel cutting, place adjustable auxiliary handle on the motor side to eliminate interference with work piece.

WARNING Because of the increased amount of blade engagement in the work and decreased stability of the foot, blade binding may occur. Keep the saw steady and the foot firmly on the workpiece.

FIG. 7

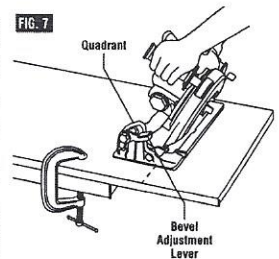

LINE GUIDE

For a 0° cut, use the large notch in the foot. For 45° bevel cuts, use the small notch (Fig. 8). The cutting guide notch will give an approximate line of cut. Make sample cuts in scrap lumber to verify actual line of cut. This will be helpful because of the number of different blade types and thicknesses available. To ensure minimum splintering on the good side of the material to be cut, face the good side down.

FIG. 8

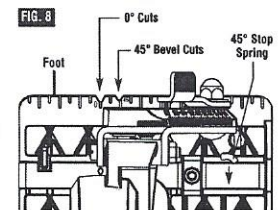

SAW HOOK

To use, lift up hook until it snaps into the open position. When not in use, always lower hook until it snaps into the closed position.

FIG. 9

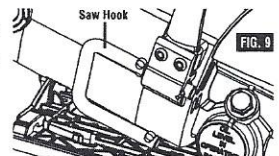

WRENCH USAGE

Wrench provided has several functions other than loosening/tightening the blade bolt (Fig. 10).

1. Loosening/tightening blade bolt (1/2" wrench).
2. Loosening/tightening oil plug (1/2" wrench).
3. Loosening/tightening brush caps (slotted driver).
4. Loosening/tightening bevel/depth levers when levers are over tightened or additional tightening is needed (9/16" wrench).
5. Blade diamond arbor knock out (wedge feature).

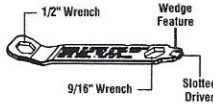
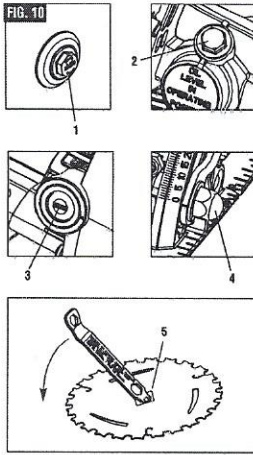

WRENCH STORAGE

Wrench storage is provided on the tool (Fig. 2). Wrench is fully seated when second lock detent is engaged.

CAUTION Wrench needs to be inserted with the correct orientation (Fig. 11). Damage to work piece could occur if inserted incorrectly.



SWITCH

WARNING When starting the tool, hold it with both hands. The torque from the motor can cause the tool to twist.

To turn tool "ON", squeeze the trigger switch. To turn the tool "OFF", release the trigger switch, which is spring loaded and will return to the off position automatically.

Your saw should be running at full speed BEFORE starting the cut, and turned off only AFTER completing the cut. To increase switching life, do not turn switch on and off while cutting.

GENERAL CUTS

Always hold the saw by the main handle with one hand and the auxiliary handle with the other.

WARNING Always be sure either hand does not interfere with the free movement of the lower guard.

Maintain a firm grip and operate the switch with a decisive action. Never force the saw. Use light and continuous pressure.

WARNING After completing a cut and released, be aware of the necessary time it takes for the blade to come to a complete stop during coast down. Do not allow the saw to brush against your leg or side, since the lower guard is retractable, it could catch on your clothing and expose the blade. Be aware of the necessary blade exposures that exist in both the upper and lower guard areas.

When cutting is interrupted, to resume cutting: squeeze the trigger and allow the blade to reach full speed, re-enter the cut slowly and resume cutting.

When cutting across the grain, the fibers of the wood have a tendency to tear and lift. Advancing the saw slowly minimizes this effect. For a finished cut, a cross cut blade or miter blade is recommended.

PLUNGE CUTS

Disconnect the plug from the power source before making adjustments. Set depth adjustment according to material to be cut. Reconnect the plug to power source.

Hold the main handle of the saw with one hand, tilt saw forward and rest front of the foot plate on material to be cut. Line up the cutting guide notch with the line you've drawn. Raise the lower guard using lower guard lift lever and hold the front of the foot plate with the other hand (Fig. 12).

Position the saw with the blade just clearing the material to be cut. Start the motor and once fully up to speed, gradually lower the back end of saw using the front end of the foot as the hinge point.

Once the foot plate rests flat on the surface being cut, release the lower guard and move the hand holding the front of the foot plate to hold the auxiliary handle. Proceed cutting in forward direction to end of cut.

WARNING Allow blade to come to a complete stop before lifting the saw from cut. Also, never pull the saw

backward since blade will climb out of the material and KICKBACK will occur. Turn saw around and finish the cut in the normal manner, sawing forward. If corners of your plunge cut are not completely cut through, use a jigsaw or hand saw to finish the corners.

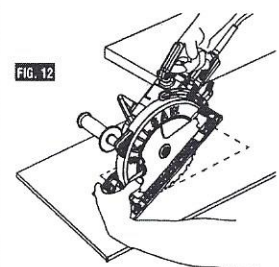

CUTTING LARGE SHEETS

Large sheets and long boards sag or bend, depending on support. If you attempt to cut without leveling and properly supporting the piece, the blade will tend to bind, causing KICKBACK and extra load on the motor (Fig. 13).

Support the panel or board close to the cut, as shown in (Fig. 14). Be sure to set the depth of the cut so that you cut through the sheet or board only and not the table or work bench. The two-by-fours used to raise and support the work should be positioned so that the broadest sides support the work and rest on the table or bench. Do not support the work with the narrow sides as this is an unsteady arrangement. If the sheet or board to be cut is too large for a table or work bench, use the supporting two-by-fours on the floor and secure.

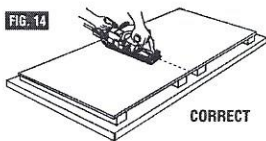
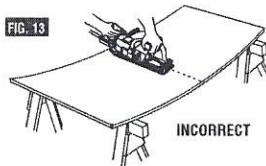

RIP CUTS

The combination blade provided with your saw is for both cross cuts and rip cuts. Ripping is cutting lengthwise with the grain of the wood. Rip cuts are easy to do with a rip fence (Fig. 15). Rip Fence is available as an accessory (not included). To attach fence, insert fence through slots in tool to desired width as shown and secure with the fastener (not included).

WARNING Ensure rip fence does not interfere with the free movement of the lower guard and saw blade. Rip fence contacting lower guard or saw blade can cause property damage and serious personal injury.

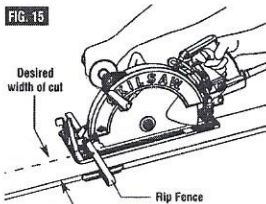

RIP BOARD GUIDE

When rip cutting large sheets, the rip fence may not allow the desired width of cut. Clamp or nail a straight piece of 1" (25 mm) lumber to the sheet as a guide (Fig. 16). Use the right side of the foot against the board guide.

WARNING Ensure the clamps do not interfere with the free movement of the saw.

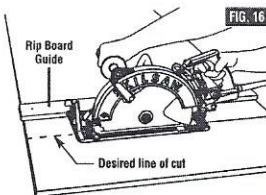

Maintenance

WARNING To avoid accidents always disconnect the tool from the power supply before cleaning or performing any maintenance.

Service

WARNING Preventive maintenance performed by unauthorized personnel may result in misplacing of internal wires and components which could cause serious hazard. We recommend that all tool service be performed by a Skil Factory Service Center or Authorized Skil Service Station.

TOOL LUBRICATION

Your Skil tool has been properly lubricated and is ready to use. However it is recommended that the gears be relubricated only with Skil lubricants: No. 80111 (8 oz. tube).

Always check the oil level before using the saw. To check and add oil. Remove plug from power source and place the saw's foot on a horizontal surface with tool set to maximum depth of cut. Remove oil plug using the same wrench used to remove the saw blade. The oil level should never be below bottom threads in the housing. When adding oil, fill until oil starts to run out of oil hole at arrow on housing and replace oil plug (Fig. 15).

NOTE: If oil is dirty or thick, replace the oil plug and run the saw for one minute to warm up the oil. Then remove oil plug and turn saw upside down, to remove all oil. Add fresh Skil lubricant. With a new saw, change the oil after the first ten hours of use.

CARBON BRUSHES

The brushes and commutator in your tool have been engineered for many hours of dependable service. To maintain peak efficiency of the motor, we recommend every two to six months the brushes be examined. The brushes should be free from dust and dirt. Brushes should be replaced when they have worn down to 3/16" in length. The brushes should slide freely in and out of the holders without sticking.

To check brushes: Disconnect plug from power source. Unscrew the brush caps on the motor housing and lift out the brushes; note which way they face, so that the brushes can be returned to their original position. To replace the blade side brush the tool needs to be set to minimum depth of cut. Clean the brush holder openings with compressed air or a clean cloth and replace the brushes and caps.

Only genuine Skil replacement brushes specially designed for your tool should be used.

BEARINGS

Bearings which become noisy (due to heavy load or very abrasive material cutting) should be replaced at once to avoid overheating or motor failure.

Cleaning

The tool may be cleaned most effectively with compressed dry air. Always wear safety goggles when cleaning tools with compressed air.

Ventilation openings and switch levers must be kept clean and free of foreign matter. Do not attempt to clean by inserting pointed objects through openings.

CAUTION Certain cleaning agents and solvents damage plastic parts. Some of these are: gasoline, carbon tetrachloride, chlorinated cleaning solvents, ammonia and household detergents that contain ammonia.

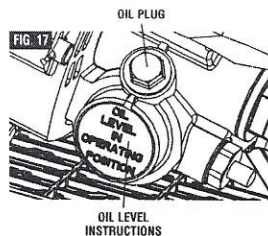

CARE OF BLADES

Blades become dull even from cutting regular lumber. If you find yourself forcing the saw forward to cut instead of just guiding it through the cut, chances are the blade is dull or coated with wood pitch.

When cleaning gum and wood pitch from blade, unplug the saw and remove the blade. Remember, blades are designed to cut, so handle carefully. Wipe the blade with kerosene or similar solvent to remove the gum and pitch. Unless you are experienced in sharpening blades, we recommend you do not try.

**TWIST-TO-LOCK CONNECTOR INSTRUCTIONS
FOR MODEL SPT70WM CODE 72 ONLY 20 AMP, 125 VOLT "TWIST-TO-LOCK"**

The Model SPT70WM code 72 is equipped with a "Twist-To-Lock" male connector as shown (Fig. 18). Use only a 3-wire extension cord which has a mating "Twist-To-Lock" female connector on one end and a 3-prong grounding plug on the other end. (See Electrical Safety section on page 2 for grounding information.)

FIG. 18

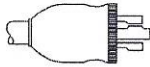

NEMA L5-20P



Extension Cords

WARNING If an extension cord is necessary, a cord with adequate size conductors that is capable of carrying the current necessary for your tool must be used. This will prevent excessive voltage drop, loss of power or overheating. Grounded tools must use 3-wire extension cords that have 3-prong plugs and receptacles.

**RECOMMENDED SIZES OF EXTENSION CORDS
120 VOLT ALTERNATING CURRENT TOOLS**

| Tool's Ampere Rating | Cord Size in A.W.G. | | | | Wire Sizes in mm ² | | | |
|----------------------------|---------------------|----|-----|-----|-------------------------------|------|-----|-----|
| | 25 | 50 | 100 | 150 | 15 | 30 | 60 | 120 |
| 3-6 | 18 | 16 | 16 | 14 | 0.75 | 0.75 | 1.5 | 2.5 |
| 6-8 | 18 | 16 | 14 | 12 | 0.75 | 1.0 | 2.5 | 4.0 |
| 8-10 | 18 | 16 | 14 | 12 | 0.75 | 1.0 | 2.5 | 4.0 |
| 10-12 | 16 | 16 | 14 | 12 | 1.0 | 2.5 | 4.0 | — |
| 12-16 | 14 | 12 | — | — | — | — | — | — |

NOTE: The smaller the gauge number, the heavier the cord.

Accessories

WARNING The use of any other accessories not specified in this manual may create a hazard.

- * Blade
- * Wrench
- ** Carrying bag

- ** Adjustable Rip Fence
- (* = standard equipment)
- (** = optional accessories)

Trouble Shooting

WARNING Read instruction manual first! Remove plug from the power source before making adjustments or assembling the blade.

- TROUBLE: SAW WILL NOT START**
- PROBLEM**
1. Power cord is not plugged in.
 2. Power source fuse or circuit breaker tripped.
 3. Cord damaged.
 4. Burned out switch.
 5. Trigger does not turn tool on.
- REMEDY**
1. Plug saw in.
 2. Replace fuse or reset tripped circuit breaker.
 3. Inspect cord for damage. If damaged, have cord replaced by an Authorized Skil Service Center.
 4. Have switch replaced by an Authorized Skil Service Center.
 5. Have switch replaced by an Authorized Skil Service Center.
- TROUBLE: BLADE DOES NOT COME UP TO SPEED**
- PROBLEM**
1. Extension cord too light or too long.
 2. Low house voltage.
- REMEDY**
1. Replace with adequate cord.
 2. Contact your electric company.
- TROUBLE: EXCESSIVE VIBRATION**
- PROBLEM**
1. Blade out of balance.
 2. Workpiece not clamped or supported properly.
- REMEDY**
1. Discard Blade and use different blade.
 2. Clamp or support workpiece as shown on pages 12 and 15.
- TROUBLE: CANNOT MAKE SQUARE CUT WHEN CROSSCUTTING**
- PROBLEM**
1. Foot not adjusted properly.
- REMEDY**
1. See "Operating Instructions" section, "Bevel Adjustment" (page 12), "Line Guide" (page 12), "Cutting Large Sheets (page 15) and "Rip Cuts" (page 15).
- TROUBLE: CUT BINDS, BURNS, STALLS MOTOR WHEN RIPPING**
- PROBLEM**
1. Dull blade with improper tooth set.
 2. Warped board.
 3. Blade binds.
 4. Improper workpiece support.
- REMEDY**
1. Discard blade and use a different blade.
 2. Make sure concave or hollow side is facing "DOWN" feed slowly, see page 15.
 3. Assemble blade and tighten Vari-Torque clutch per "Assembly Instructions", see page 10.
 4. Clamp or support workpiece as shown on pages 12 and 15.
- TROUBLE: BLADE SLIPPING**
- PROBLEM**
1. Tool does not cut workpiece.
- REMEDY**
1. Assemble blade and tighten Vari-Torque clutch per "Assembly Instructions", see page 10.